



**Manufacturers of
Quality Wood Mouldings**

**P.O. Box 488
310 Harrison Street
Phone (870) 898-5146
Ashdown, Arkansas 71822**

Eighth Edition

Little River Millwork has manufactured and distributed quality wood mouldings for over 30 years serving Arkansas, Louisiana and the surrounding area. We take pride in the quality of our products and in our service to all of our customers. We offer stain grade, finger-joint, primed finger-joint, MDF mouldings, and accessories. We maintain a large inventory of finished moulding, blanks, and raw material to have the moulding you need, when you need it. Our plant is located in Ashdown, Arkansas, assuring you that if we do sell out of a pattern, we will have it in a few days rather than in a few weeks as with foreign manufacturers.

White Fir's light color, long grain, and wood stability offer your customer a great choice in quality stain grade mouldings. We mill our solid White Fir stain grade mouldings at our Ashdown, Arkansas plant. We grade to high standards to offer you the best quality and inventory—over 150 different profiles to offer your customer a great choice.

Paint grade mouldings are offered both raw and pre-primed. Finger-joint mouldings—available in both pine and White Fir—offer your customer an economical option in paint grade wood mouldings. Pre-primed paint grade wood mouldings offer your customer a time-saving convenience. Using only quality latex primers, we prime our mouldings with a true prime coat, not a whitewash, and we bake on the finish.

Wood mouldings are shipped in random lengths from 6 ft. to 16 ft. in multiples of 1 ft. No more than 15% of any one pattern shall be under 8 ft. When computing the percentage of shorts in casing and stop, pieces 7 ft. in length are considered long lengths. There is an upcharge for specified lengths.

MDF mouldings offer a full-length, blemish-free moulding. We distribute various profiles from Pacific MDF Products, Inc. (Pac-Trim). Pac-Trim offers the best MDF product and finish available, using only domestic, moulding and better grade MDF for a strong, smooth finish. Pac-Trim primes with two coats of primer, buffing before and after each coat, for a smooth, ready-to-paint finish. We offer all of our patterns in the Pac-Lite, 38 lb. style, as it is the easiest for the installer to work with. Pac-Trim offers a selection of primed rosettes, plinth blocks, base corners, and crown corners to match and compliment their mouldings

Flexible mouldings allow the builder and designer flexibility not available in wood mouldings. We are a distributor of Carter Millwork's flexible mouldings in patterns that match our profiles. CarterFlex ships in-stock items the next day and most specials within one week. Circle top, arch top, elliptical and radius are formed pre-bent to match your application for ease of installation. CarterFlex mouldings machine like wood, can be painted or stained, and are acceptable for interior and exterior installations. CarterFlex carries a lifetime manufacturer's warranty.

Your order will arrive clean and dry in our fleet of modern trucks. Our trailers' flexible tops protect your order, and fold out of the way to make unloading easy. The whole top folds out of the way, allowing your forklift full access to your order.

We look forward to the opportunity to serve you for your moulding needs. We at Little River Millwork, Inc. take pride in our quality products, large selection, and fast, friendly service. Please call us with any questions or comments.

CROWNS

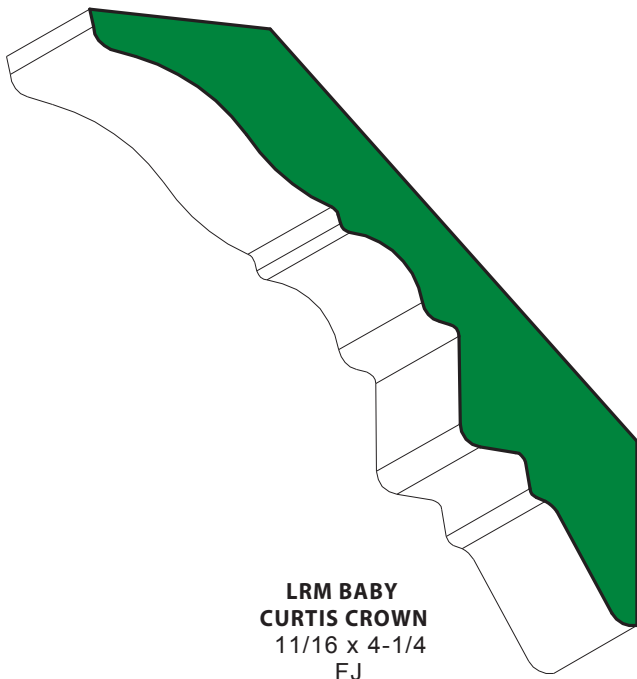

**LRM BABY
CURTIS CROWN**
11/16 x 4-1/4
FJ

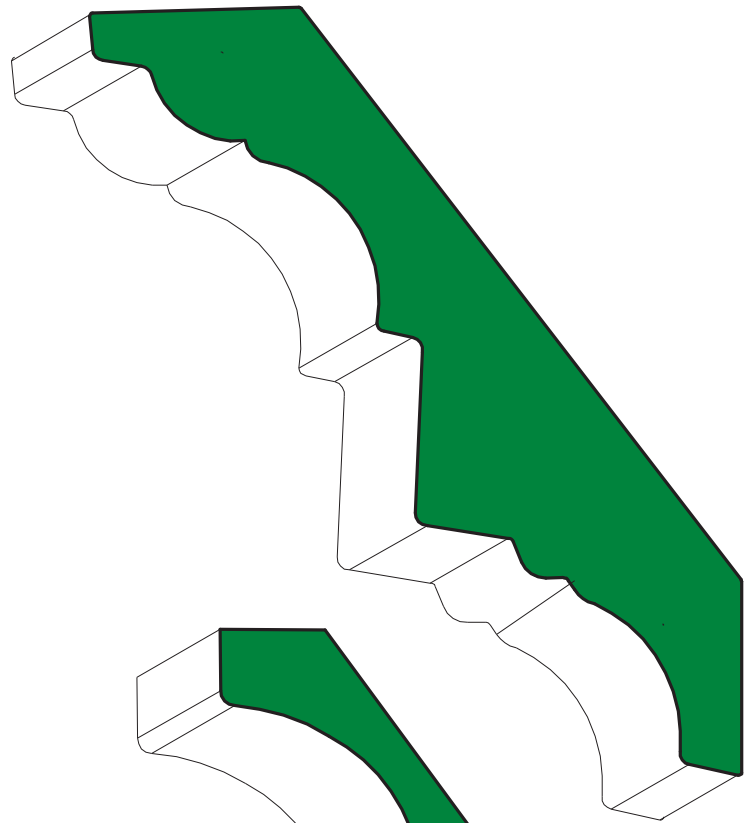

LRM CURTIS CROWN
1-1/8 x 5-1/4
WF, FJ

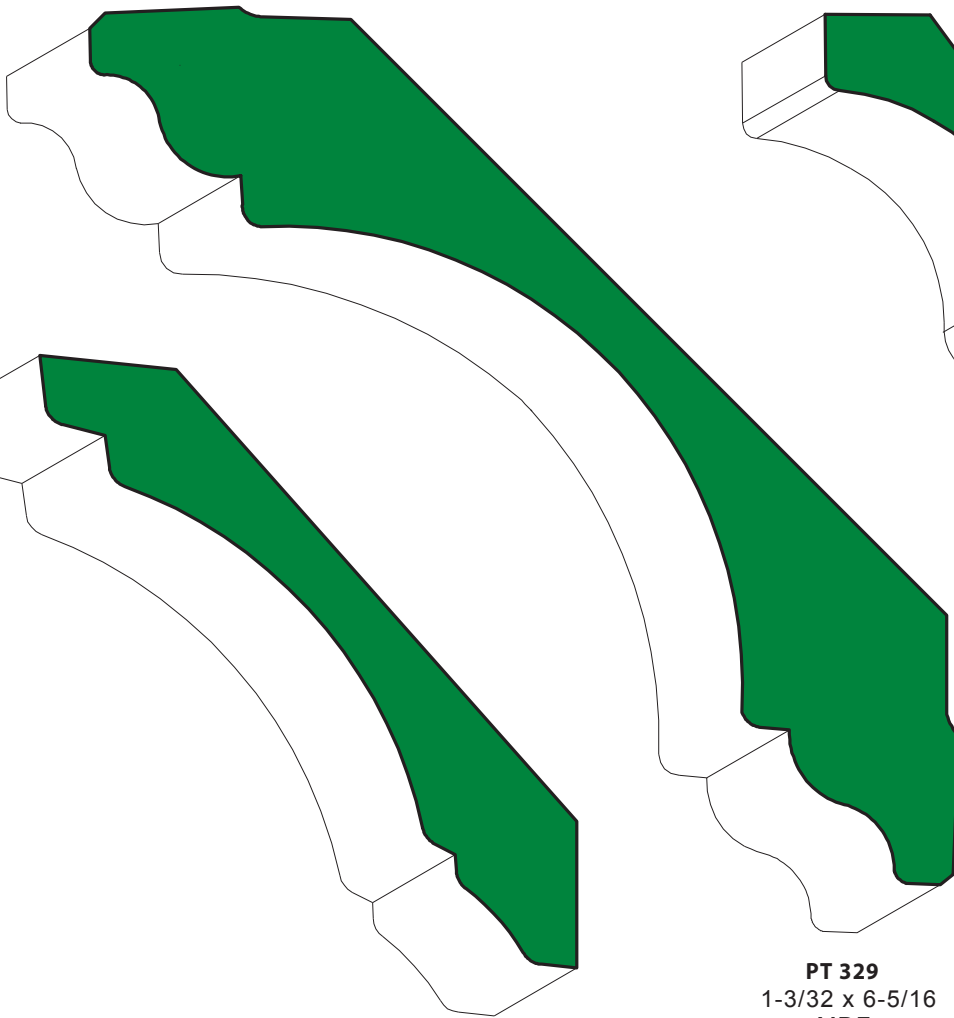

LRM 4 1/4 COVE CROWN
1 1/16" x 4-3/16
FJ

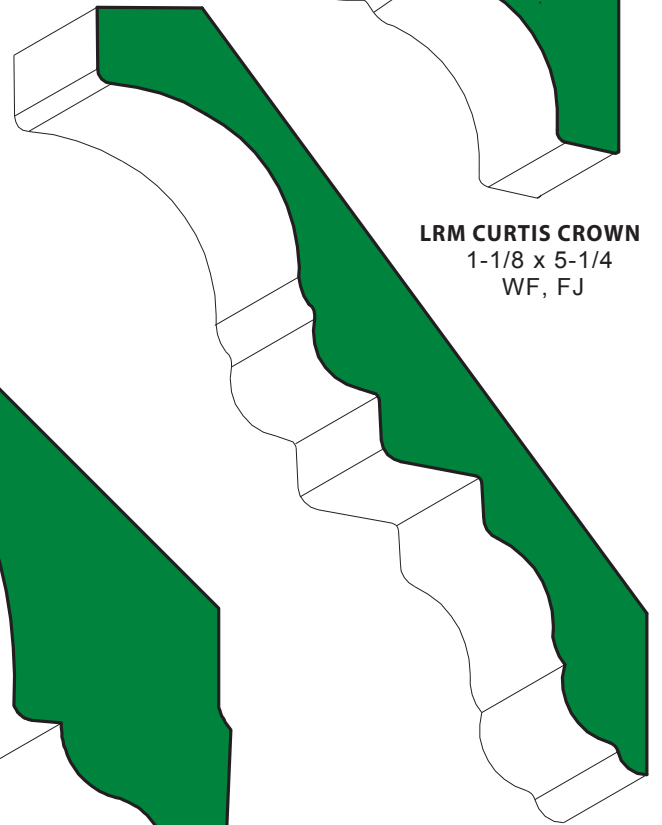

LRM RC CROWN
11/16 x 4-15/16
FJ

PT 329
1-3/32 x 6-5/16
MDF

CROWNS

A decorative accent where the wall and ceiling meet. Combine with bases casing and other moulding for a larger, more dramatic look.

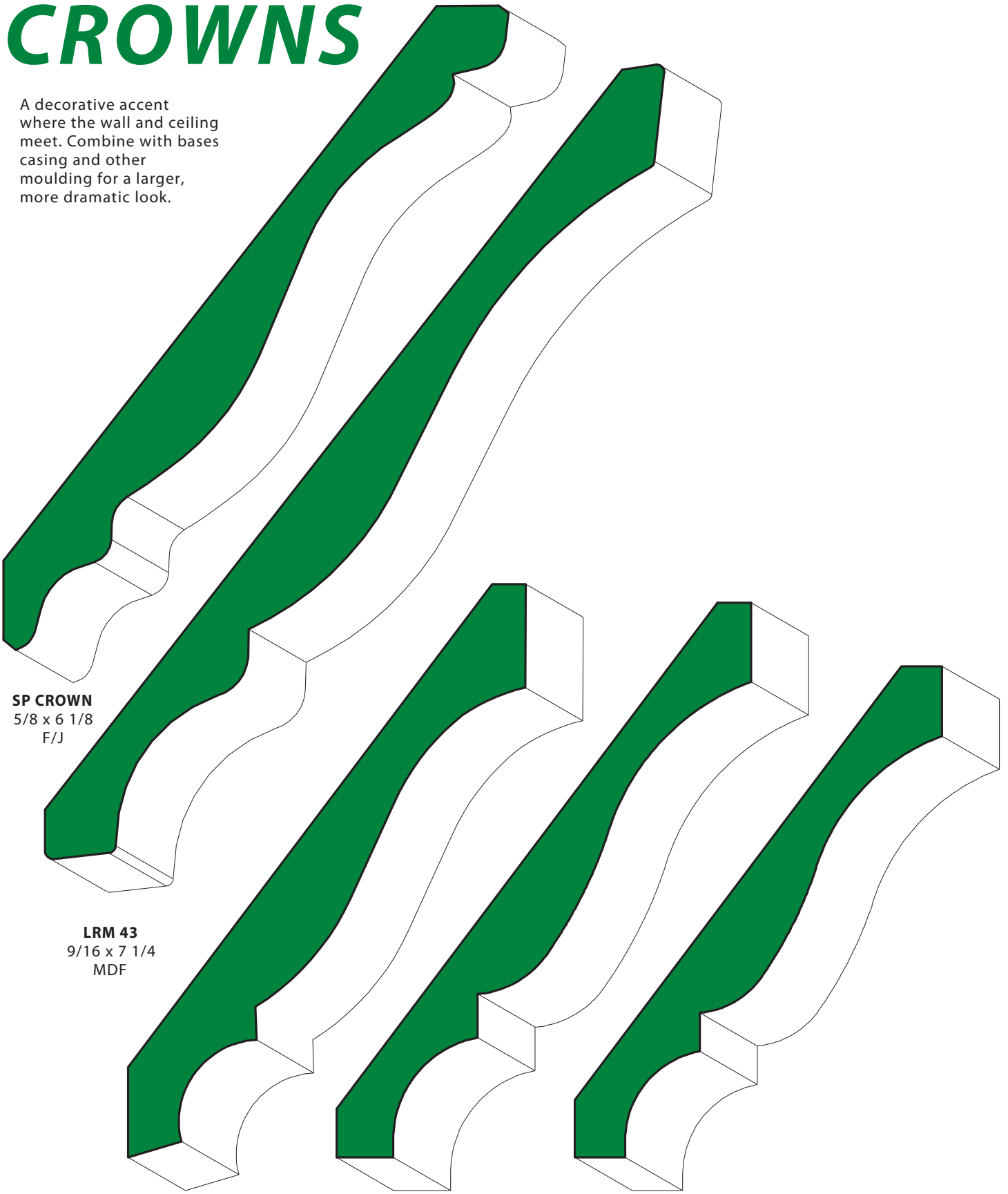

SP CROWN
5/8 x 6 1/8
F/J

LRM 43
9/16 x 7 1/4
MDF

LRM L45
11/16 x 5 1/4
FJ

LRM 45
9/16 x 5 1/4
WF, F/J, PM, MDF

LRM 47
9/16 x 4 5/8
WF, FJ

CROWNS

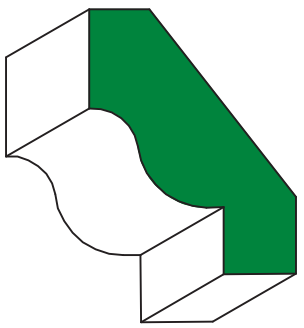

LRM 60
9/16 x 1 3/4
WF

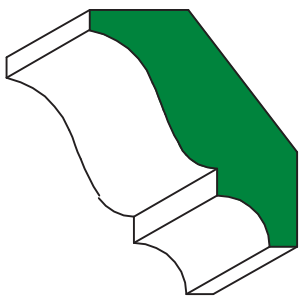

LRM 68
9/16 x 1 5/8
WF

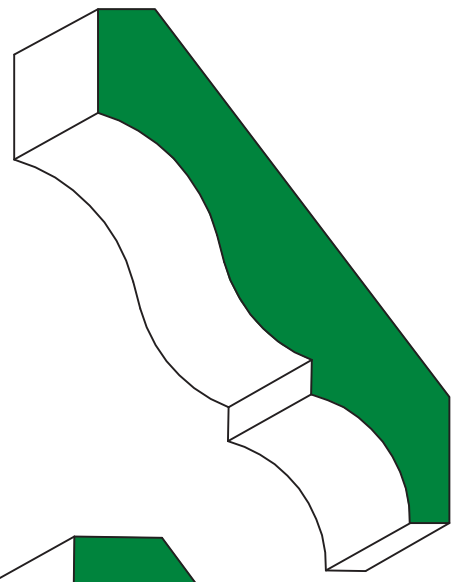

LRM 51
9/16 x 3 1/4
WF, FJ, PM, MDF

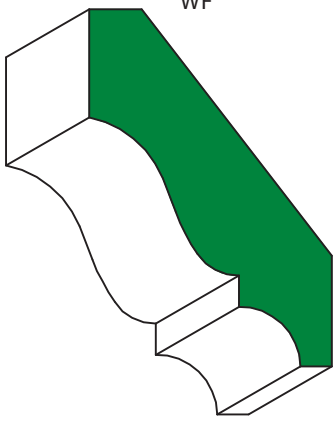

LRM 54
9/16 x 2 1/4
WF, FJ

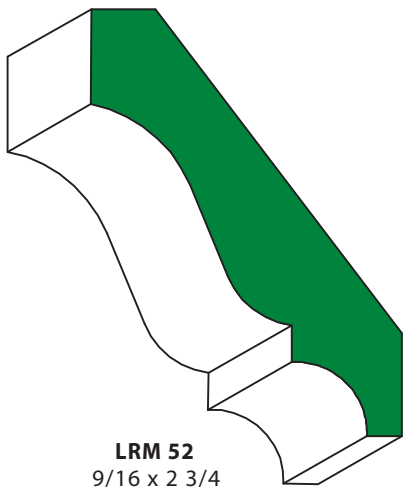

LRM 52
9/16 x 2 3/4
WF, FJ, PM

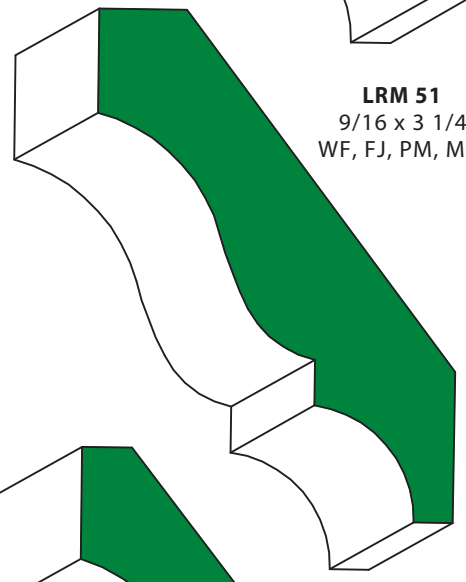

LRM L51
11/16 x 3 1/4
FJ

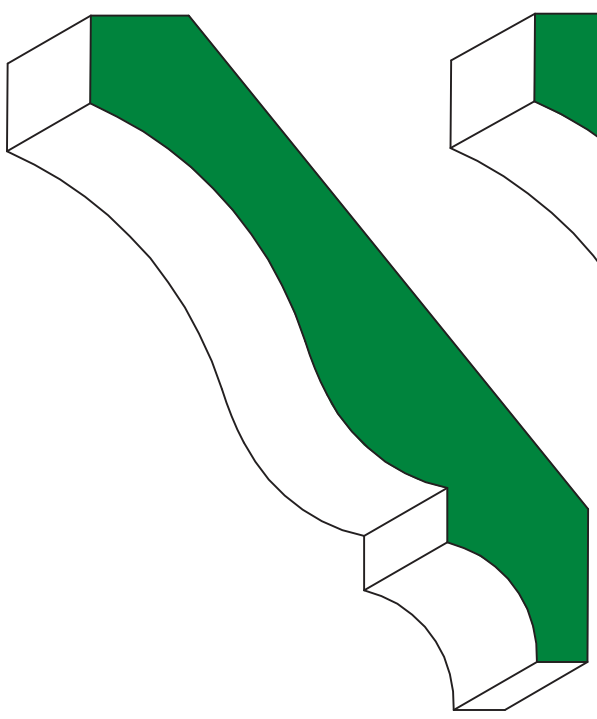

LRML48
11/16 x 4 1/4
WF, FJ

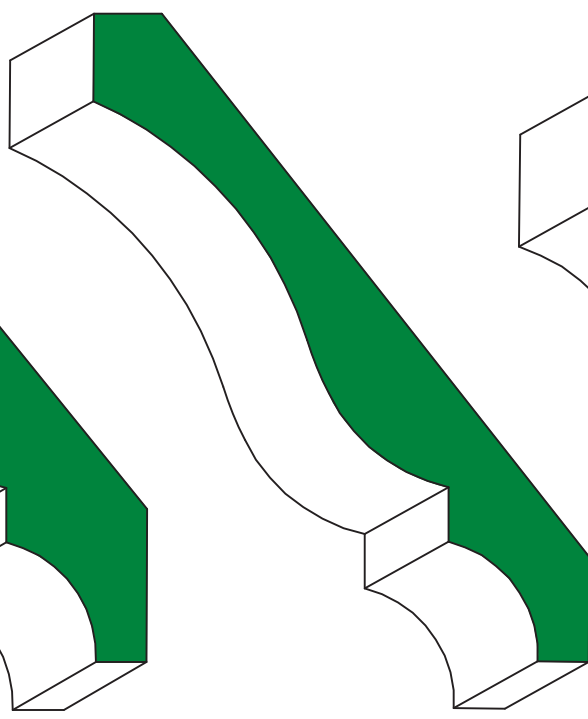

LRM 48
9/16 x 4 1/4
WF, FJ, PM, MDF

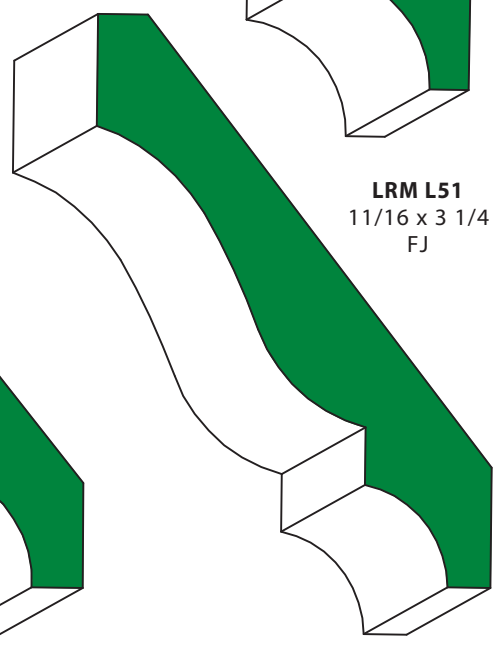

LRM 49
9/16 x 3 5/8
WF, FJ, PM

WF - SOLID WHITE FIR STAIN GRADE
FJ - FINGER JOINT PAINT GRADE
PM - PRIMED FINGER JOINT PAINT GRADE
MDF - PRIMED MEDIUM DENSITY FIBERBOARD

BEDS

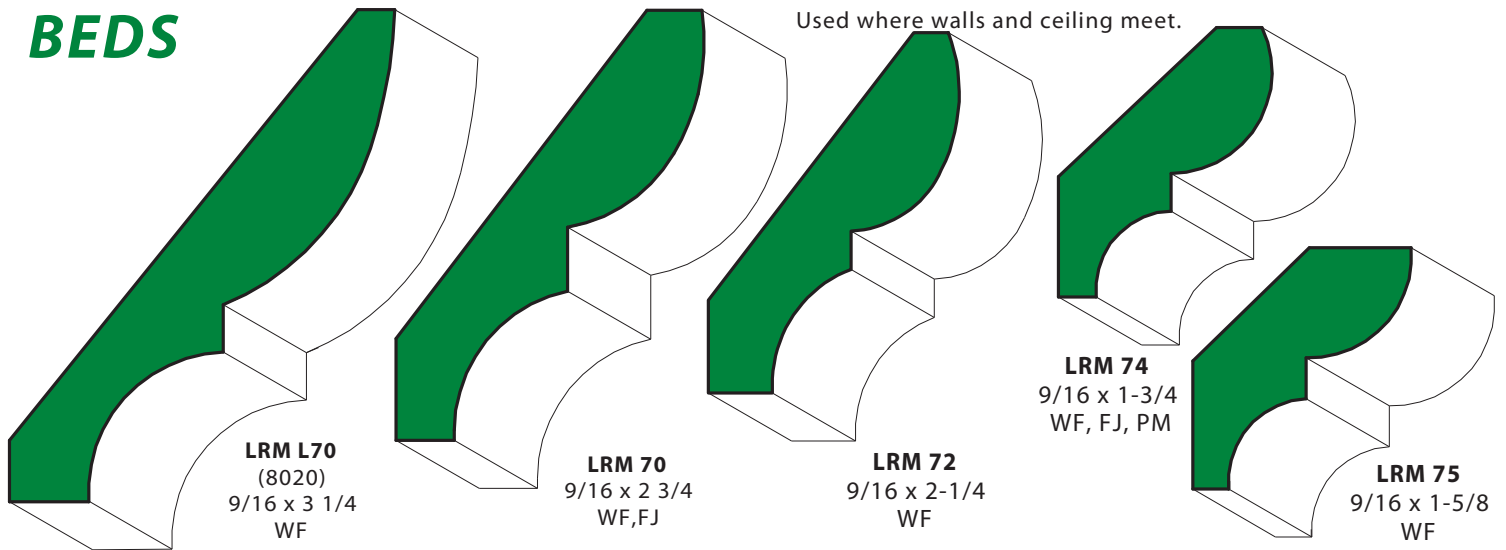

COVES

Concave profile. Used at corners, particularly as a ceiling cornice. Small Coves may be used as an inside corner guard

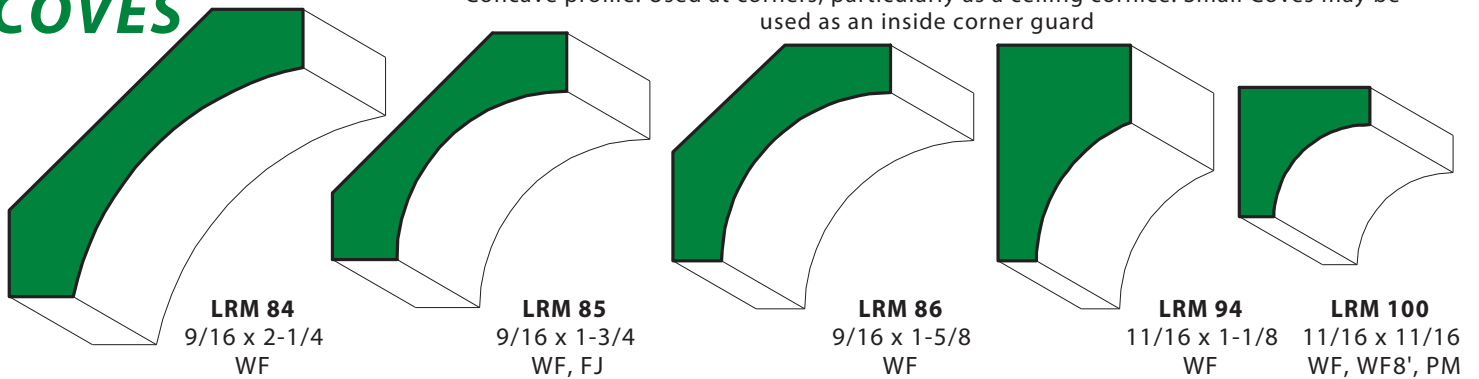

CORNER GUARDS

Outside Corner Guard is used to protect corners or to cover ragged edges where wall covering and painted surfaces meet at outside corners.

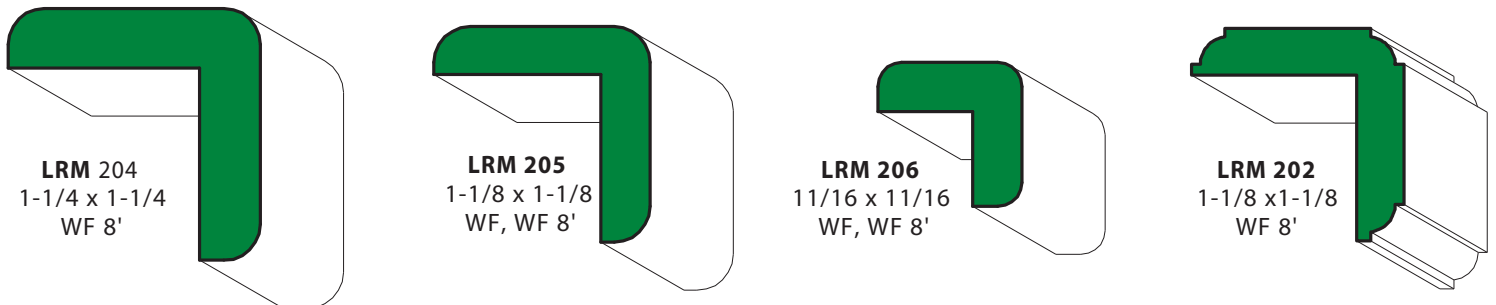

CHAMFER STRIP

LRM 995
11/16 x 11/16
WF

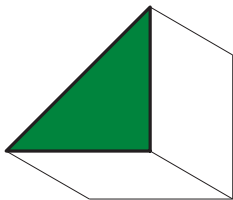

Used in concrete forms, making chamfered edge at concrete corners. Also used for covering corners under laminate kitchen tops and under flooring.

INSIDE CORNER

LRM 999
5/16 x 1
WF8'

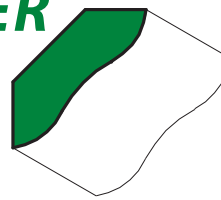

Joins two walls at an inside corner. Solves problems of uneven joints where butted panels, wallpaper, painted or contrasting surfaces meet. Gives corners a decorative, finished look.

GLASS BEAD

LRM 148
3/8 x 3/8
WF

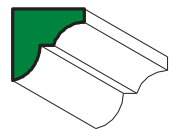

Used to hold glass in place. Also called Glass Stop, Cove & Bead, Putty Bead, Glazing Bead and Staff Bead.

QUARTER ROUNDS

May be used as a Base Shoe, Inside Corner Moulding, or to cover any 90 degree juncture.

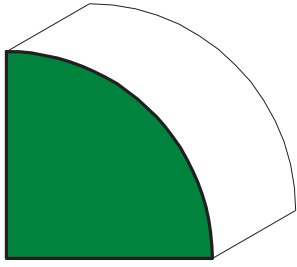

LRM 103
1-1/16 x 1-1/16
WF, FJ

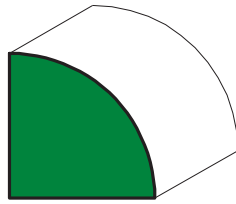

LRM 106
11/16 x 11/16
WF, FJ, PM, OAK

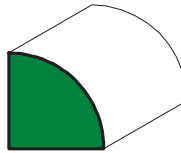

LRM 108
1/2 x 1/2
WF

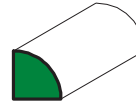

LRM 110
1/4 x 1/4
WF

BASE SHOE

Applied where Base Moulding meets floor. Protects Base from damage. Conceals uneven lines or cracks where Base meets floor.

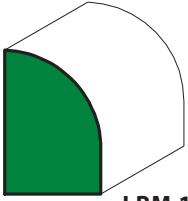

LRM 126
1/2 x 3/4
WF, FJ, PM

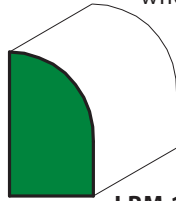

LRM 127
7/16 x 3/4
OAK

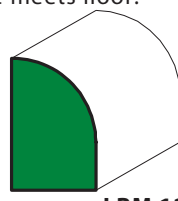

LRM 129
7/16 x 11/16
WF, FJ, PM

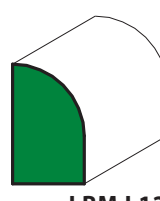

LRM L129
3/8 x 5/8
WF7'

SHELF EDGE SCREEN MOULD

Covers seam where screening is fastened to the screen frame
Also covers particle or flake board shelf edges.

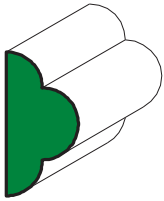

LRM 137
3/8 X 3/4
WF

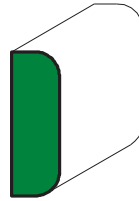

LRM 142
1/4 X 3/4
WF



LRM 144
1/4 X 3/4
WF

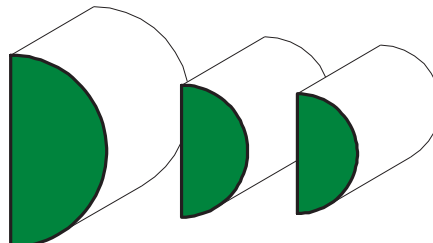

LRM 120
1/2 x 1
WF

LRM 122
3/8 x 11/16
WF

LRM 123
5/16 x 5/8
WF

DRIP CAPS

Applied over exterior window & door frames. Keeps water from seeping under the siding. Directs water away from window glass.

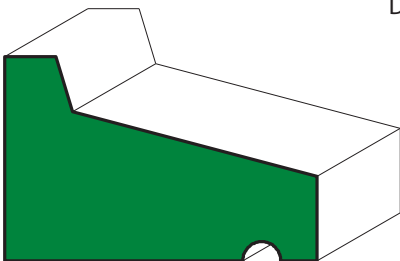

LRM 188
1-1/16 x 1-5/8

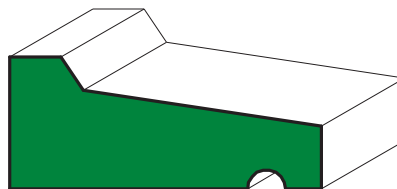

LRM 197
11/16 x 1-5/8

ROUNDS

Most often used as closet pole or room dividers.

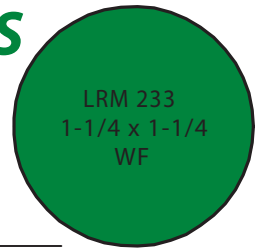

LRM 233
1-1/4 x 1-1/4
WF

PARTING STOP



LRM 254
1/2 X 3/4
WF

SQUARES



LRM 239
11/16 X 11/16
WF

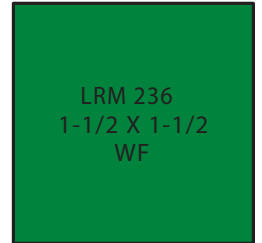

LRM 236
1-1/2 X 1-1/2
WF

Used in cabinets, framing for shelves or other utilitarian uses. Also used as balusters for supporting stair handrails

SCREEN/S4S

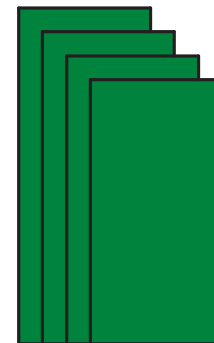

LRM 248
11/16 x 1 3/4
WF, FJ, WFE4E

LRM 249
11/16 x 1 5/8
WF, FJ

LRM 250
11/16 x 1 1/2
WF, FJ, PM

LRM 251
11/16 x 1 3/8
WF, FJ

Used in cabinets, framing for shelves or other utilitarian uses. Also used as balusters for supporting stair handrails.

LATTICE



LRM 265 1/4 x 1-3/4 WF
LRM 266 1/4 x 1-5/8 WF
LRM 267 1/4 x 1-3/8 WF
LRM 268 1/4 x 1-1/8 WF

Originally used in trellis work. This small plain S4S Moulding is among the most versatile of profiles.

BASE CAP

A Decorative Accent installed flush against the wall on top of a S4S Baseboard. Also used as a panel mould and an accent on a stacked crown.

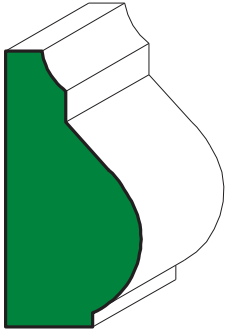

LRM THUMBNAIL
11/16 x 1-1/2
FJ

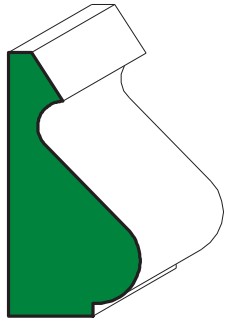

LRM 163
11/16 x 1-3/8
WF

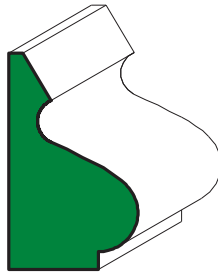

LRM 164
11/16 x 1-1/8
WF, FJ

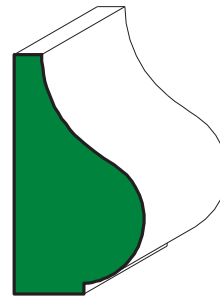

LRM 166
11/16 x 1-1/4
WF

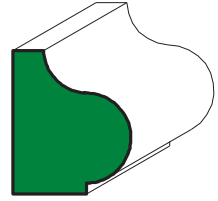

LRM 172
5/8 x 3/4
WF, FJ

BACK BAND

A rabbeted moulding used to surround the outside edge of casing.

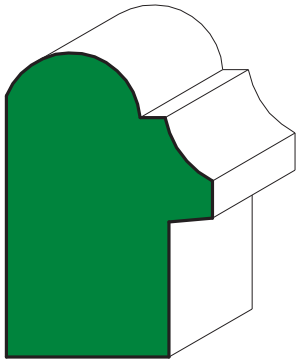

LRM 238
1-1/16 x 1-5/8
FJ

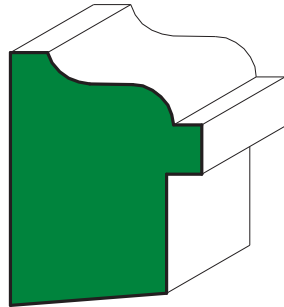

LRM 125
1 x 1-1/4
WF, FJ

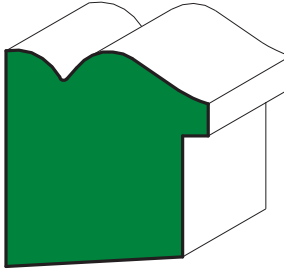

LRM 279
1-1/16 x 1-1/8
WF, FJ

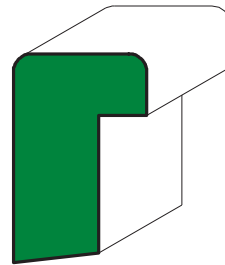

LRM 280
11/16 x 1-1/16
WF

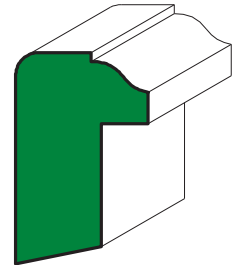

LRM 281
11/16 x 1-1/8
WF

PANEL STRIPS/MULLION CASINGS

Mullion Casing, used to cover the joint between two window units.
Panel Strip, used in decorative wall treatments.

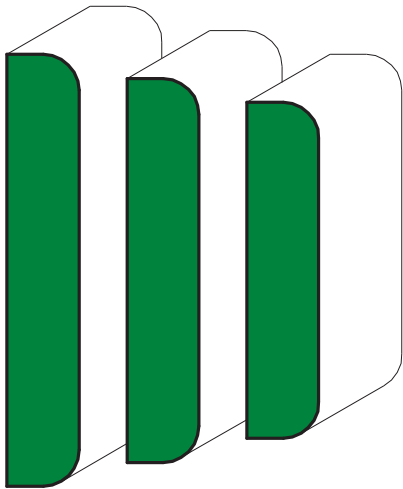

LRM 970
3/8 x 2-1/4
WF

LRM 972
3/8 x 2
SPL

LRM 973
3/8 x 1-3/4
SPL

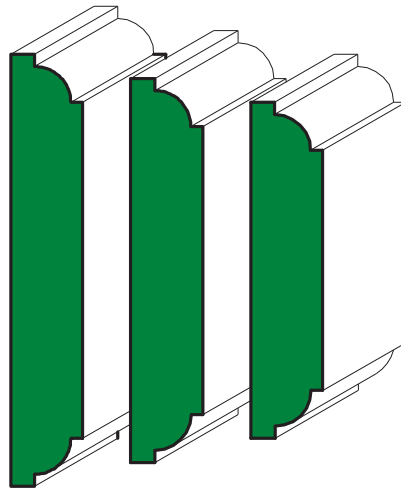

LRM 975
3/8 x 2-1/4
SPL

LRM 977
3/8 x 2
SPL

LRM 978
3/8 x 1-3/4
WF

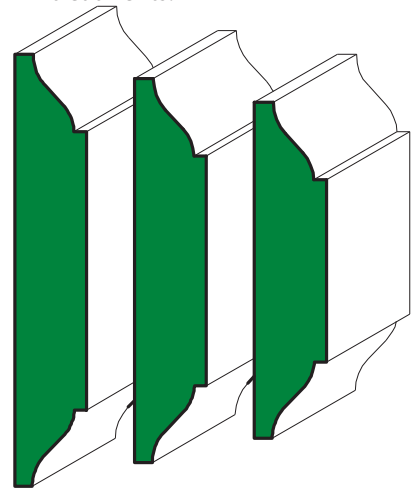

LRM 980
3/8 x 2-1/4
SPL

LRM 982
3/8 x 2
SPL

LRM 983
3/8 x 1-3/4
WF

HAND RAIL

Used as a hand support in a stairwell

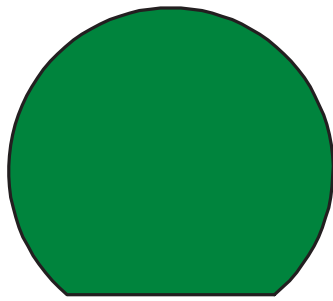

LRM 231
1-1/2 x 1-11/16
WF

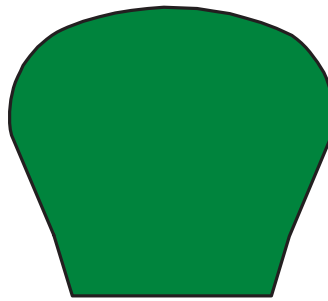

LRM 230
1-1/2 x 1-11/16
WF

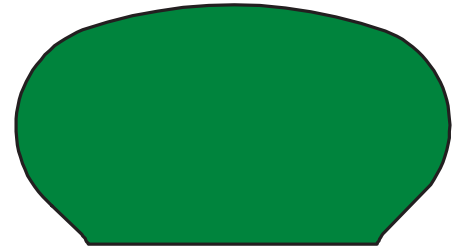

LRM 240
1-1/4 x 1-1/4
WF

NOSINGS



LRM NOSING 1-3/8
7/16 x 1-3/8
WF



LRM STD NOSING
11/16 x 1-1/4
WF



LRM NOSING 1-5/8
11/16 x 1-5/8
FJ



LRM NOSING 2-1/4
1-1/16 x 2-1/4
FJ

FLAT STOOL

A moulded edged trim used to finish the bottom of a window opening frame.



LRM 1021
11/16 x 5-1/4
WF, FJ, PM, MDF

LRM L1021
11/16 x 5-3/4
FJ

RABBETED STOOL

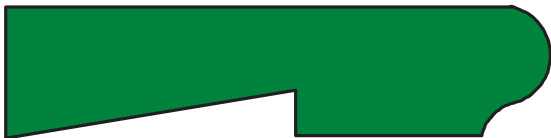

LRM 1193 11/16 x 3-1/4 WF, FJ
LRM 1194 11/16 x 2-3/4 WF
LRM 1195 11/16 x 2-1/2
LRM 1196 11/16 x 2-1/4

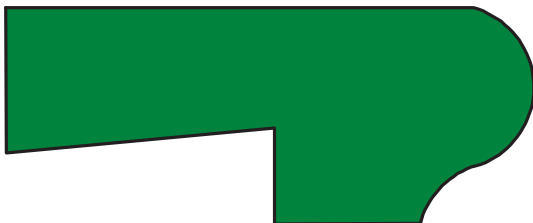

LRM 1161 1-1/16 x 3-5/8
LRM 1163 1-1/16 x 3-1/4 WF
LRM 1164 1-1/16 x 2-3/4

JAMBLINER/S4S

Used to line the inside of windows and can be used as a moulding and to build up stacked moulding.



LRM JAMB LINER 11/16 x 3-11/16 FJ
LRM S4S-4 11/16 x 3-1/4 WF, FJ
LRM S4S-6 11/16 x 5-1/4 WF, FJ
LRM 1X4 11/16 x 3-1/2 MDF
LRM 1X6 11/16 x 5-1/2 MDF
LRM 1X8 11/16 x 7-1/4 MDF
LRM 1X12 11/16 x 11-1/4 MDF

BEAM BEAD

An accent mould for the corners of beams and columns.

LRM BEAM BEAD
3/4 x 3/4
WF

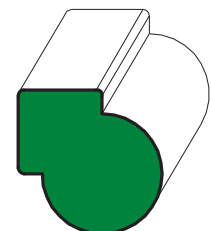

CHAIR RAIL

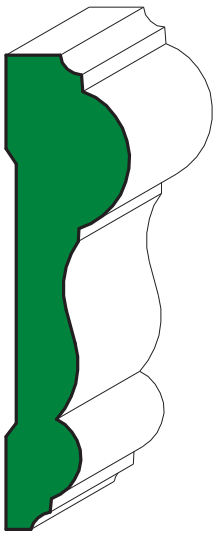

LRM 298
11/16 x 2 1/2
WF

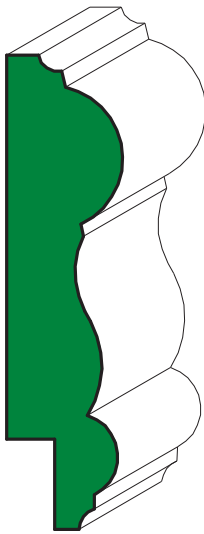

LRM 298R
7/8 x 2 1/2
WF

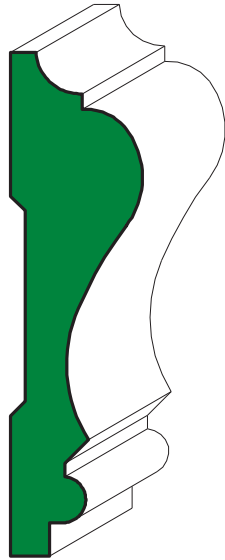

LRM 390
11/16 x 2 5/8
WF, FJ, PM, MDF

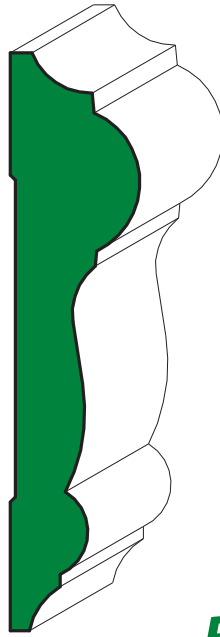

LRM 297
11/16 x 3
WF, FJ

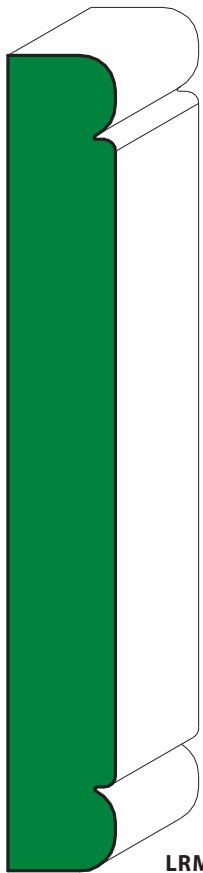

LRM 304H
9/16 x 4 1/4
WF, FJ

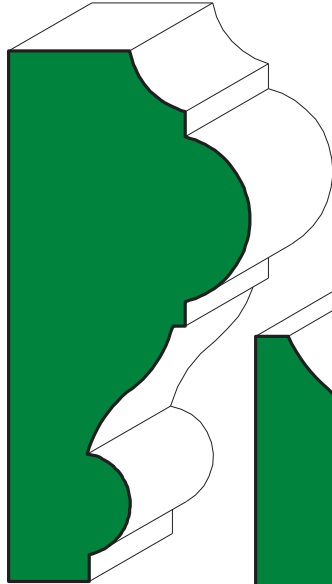

LRM LBD1
1 1/4 x 2 3/4
FJ

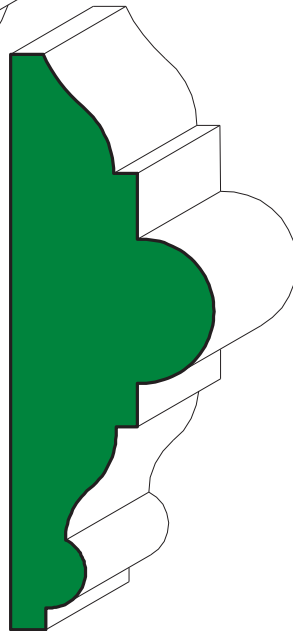

LRM 300
1 1/16 x 3
WF, FJ

LRM L 304H
21/32 X 6
FJ

PICTURE MOULDING

Used to support hooks for picture hanging. Applied around the room's circumference, near the ceiling line.

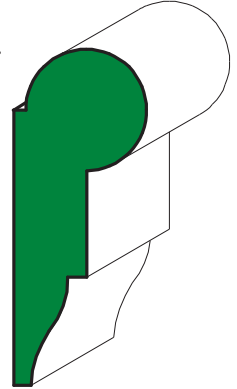

LRM 273
11/16 x 1-3/4
WF, FJ

BATTEN

A symmetrical pattern used to conceal the line where two parallel boards or panels meet.

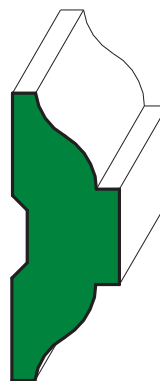

LRM L224
9/16 x 1 1/2
WF

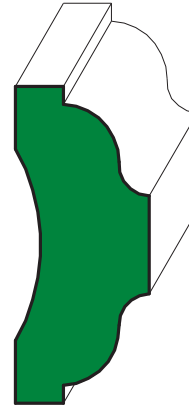

LRM 229
11/16 x 1-5/8
WF

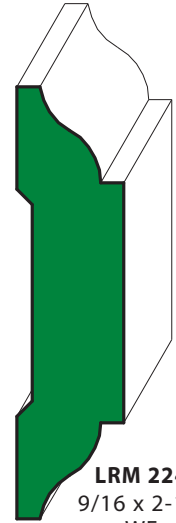

LRM 224
9/16 x 2-1/4
WF

FLAT ASTRAGALS

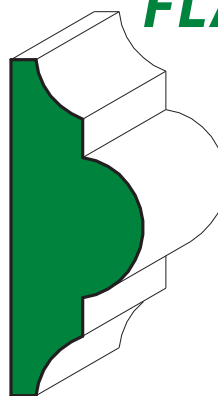

LRM 133
11/16 X 1-3/4
WF

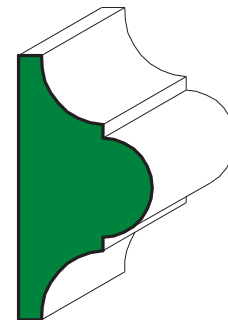

LRM 134
11/16 x 1-3/8
WF

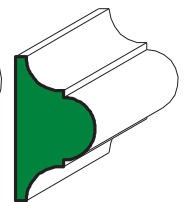

LRM 135
7/16 x 3/4
WF

Trims out the upper edge or top of a Wainscot. Covers plywood's rough sandwich edge in installations where it's exposed to view. Also called a Dado Cap.

WAINSCOT/PLY CAP

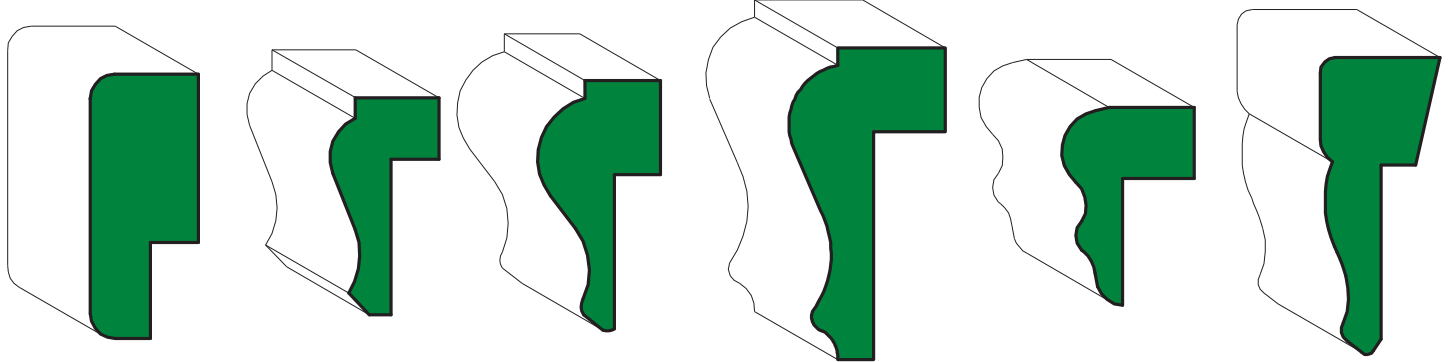

LRM 291
9/16 x 1-3/8
WF

LRM 292S
9/16 x 1-1/8
WF

LRM 292
11/16 x 1-3/8
WF

LRM 293
3/4 x 1-5/8
WF

LRM 293S
11/16 x 1-1/16
WF

LRM 1219
5/8 x 1-9/16
WF

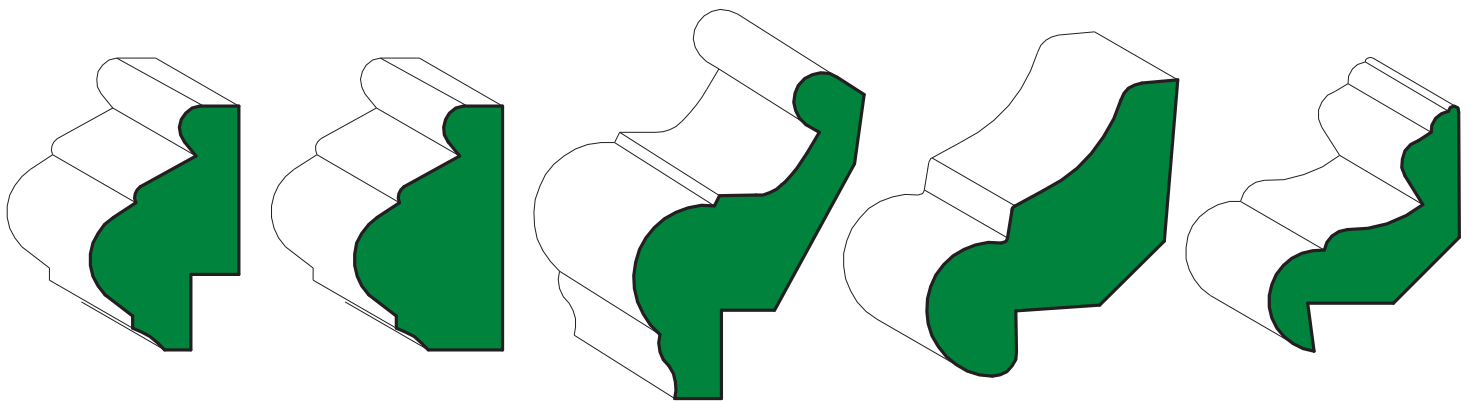

LRM PM-R
3/4 x 1-1/4
WF

LRM PM-1
3/4 x 1-1/4
WF

LRM PM-6
3/4 x 1-15/16
WF, FJ

LRM DROP PANEL
11/16 x 1-7/8
FJ

LRM SP 143
9/16 x 1-7/16
WF, FJ

Originally used to trim out raised panel wall construction. Now, often used to frame attractive wall coverings for a paneled effect.

PANEL MOULD

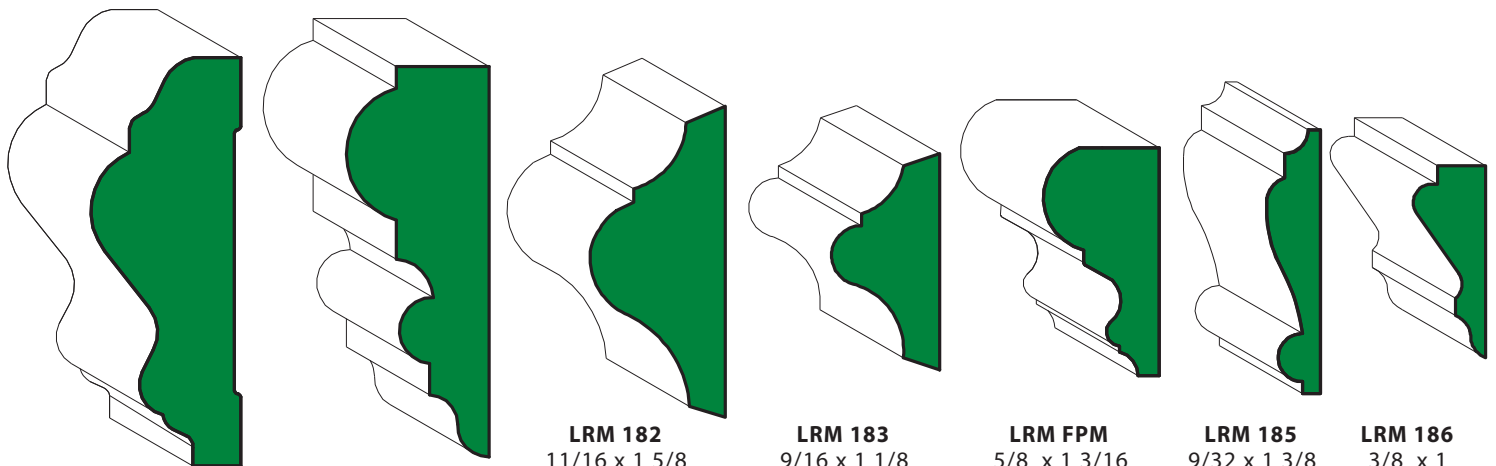

LRM CP-1
3/4 x 2-1/8
FJ

LRM 8296
11/16 x 2
WF, FJ

LRM 182
11/16 x 1 5/8
WF

LRM 183
9/16 x 1 1/8
WF

LRM FPM
5/8 x 1 3/16
FJ

LRM 185
9/32 x 1 3/8
WF

LRM 186
3/8 x 1
WF

WF - SOLID WHITE FIR STAIN GRADE
FJ - FINGER JOINT PAINT GRADE
PM - PRIMED FINGER JOINT PAINT GRADE
MDF - PRIMED MEDIUM DENSITY FIBERBOARD

CASING

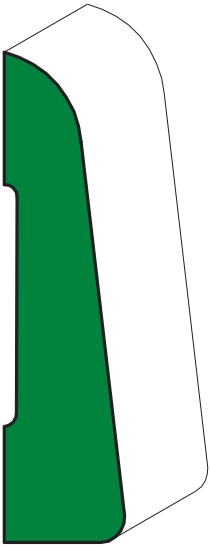

LRM E TRIM
5/8 x 2-1/2
WF, FJ, WF 7'

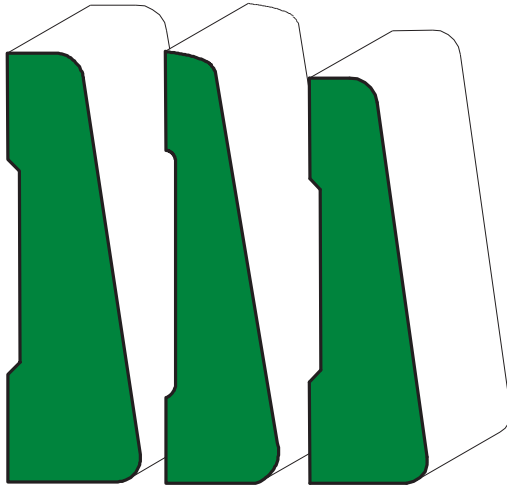

LRM 324
11/16 x 2-1/4
WF, FJ, PM
WF7', FJ7', PM7'

LRM PT 324
9/16 x 2-1/4
MDF

LRM SL-6
5/8 x 2-1/8
WF, FJ, WF7'

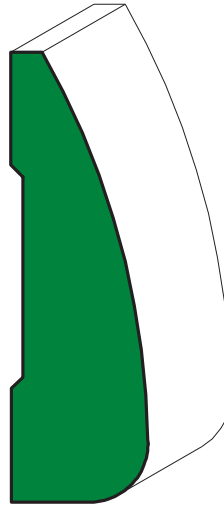

LRM 329
11/16 x 2-1/4
WF, FJ, PM, WF7'

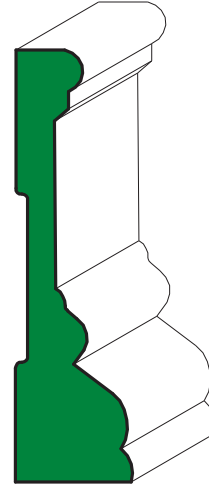

LRM BABY HOWE
11/16 x 2-1/4
FJ

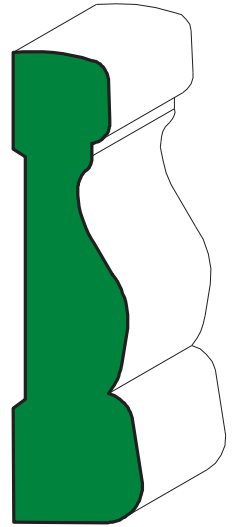

LRM ACASING
5/8 x 2-1/2
WF, FJ, WF 7', FJ 7'

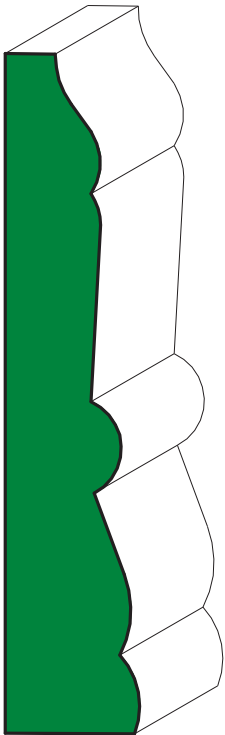

LRM 11C
11/16 x 3 1/2
MDF

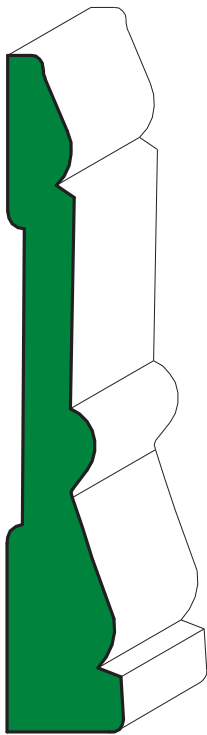

LRM LC11
11/16 x 3 1/2
FJ

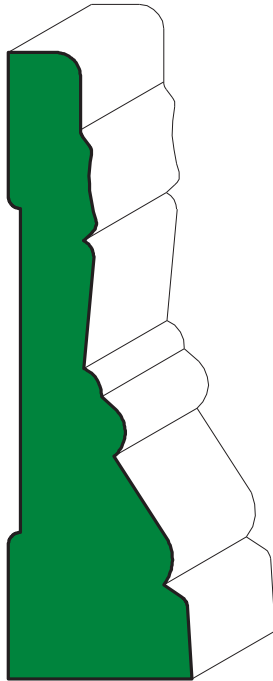

LRM 9E
15/16 x 3 1/4
PM

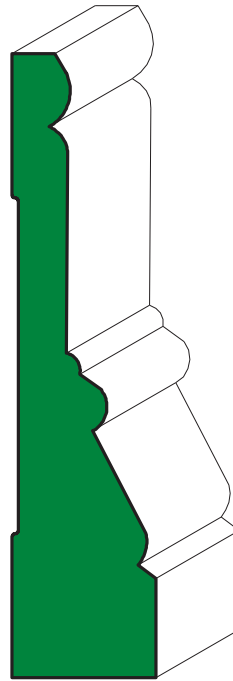

LRM 400
3/4 x 3-1/4
WF, FJ

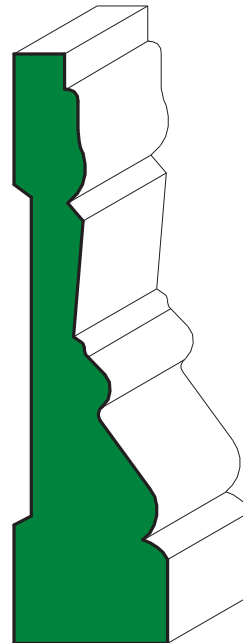

LRM L399
13/16 x 3
WF, FJ, FJ 7'3"

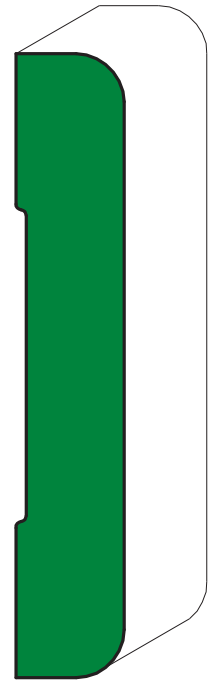

LRM 433
9/16 x 3 1/4
FJ

CASING

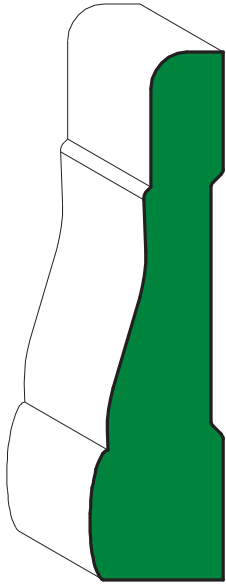

LRM L356
11/16 x 2-3/4
WF, FJ

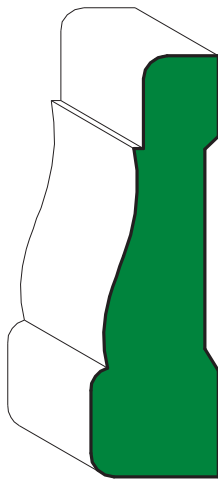

LRM 356
11/16 x 2-1/4
WF, FJ, PM, MDF
WF7', FJ7', PM7'

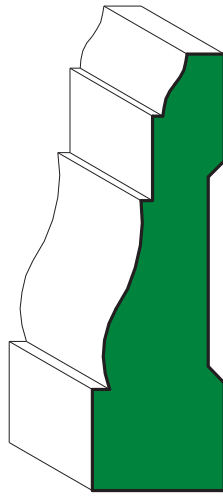

LRM 366
11/16 x 2-1/4
WF, FJ

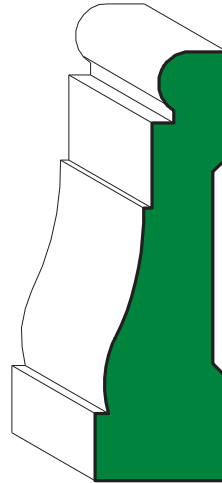

LRM 376
11/16 x 2-1/4
FJ

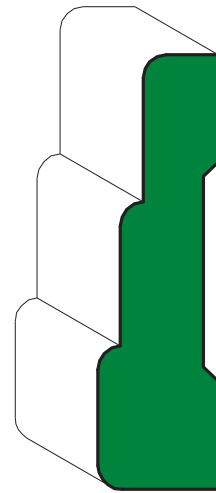

LRM 387
5/8 x 2-1/4
WF

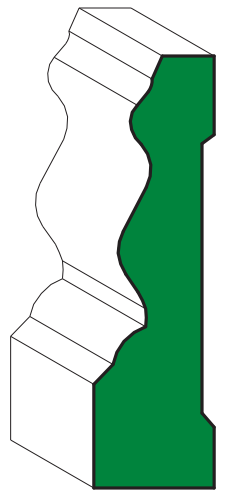

LRM HI LINE
5/8 x 2-1/4
WF, FJ

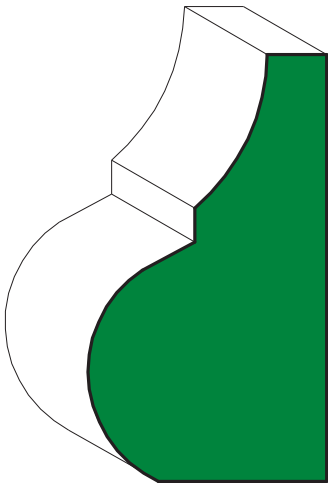

LRM JB1
1 1/4" x 2 1/4
FJ

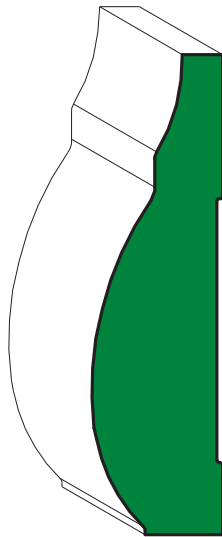

LRM SF-1
11/16" x 2-1/2
FJ

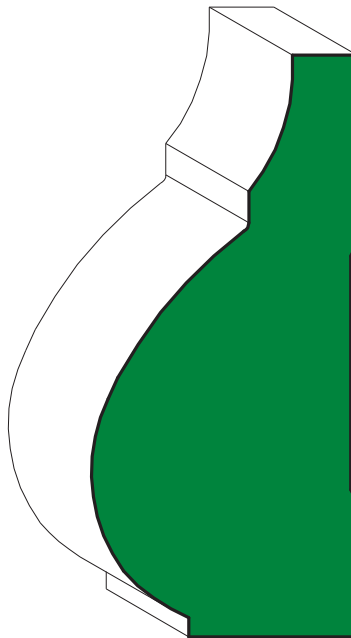

LRM FOGELMAN
1-3/8" x 3
FJ

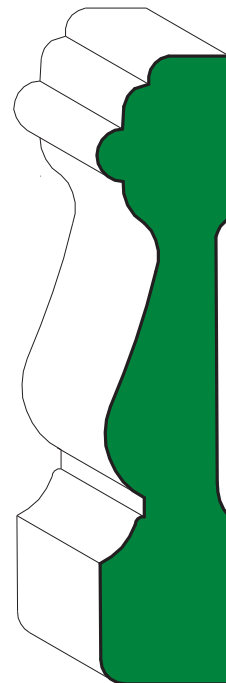

LRM 140
11/16 x 3 1/4
MDF

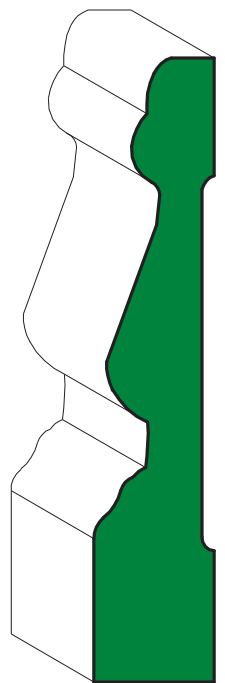

LRM HI LINE
5/8 x 3-1/4
WF, FJ, PM
FJ 7'3"

CASING

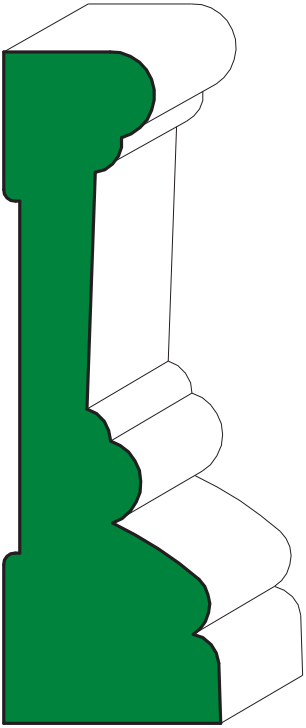

LRM HOWE
1 1/8 x 3 1/2
WF, FJ

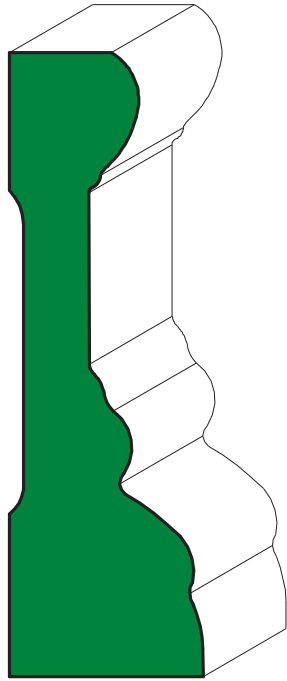

LRM PT3
1 x 3 1/4
MDF

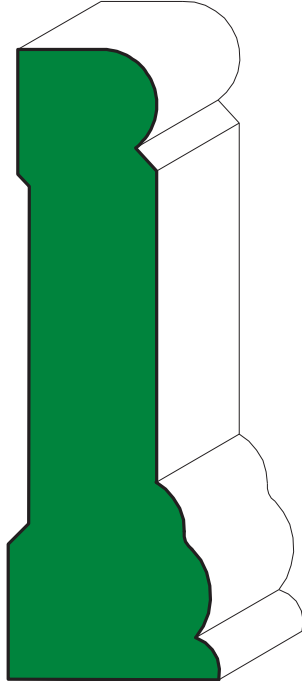

LRM SP376
1 1/16 x 3 1/4
WF, FJ, FJ 7'3"

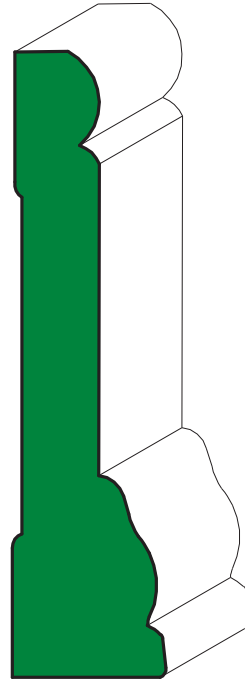

LRM THIN SP376
13/16 x 3 1/4
FJ

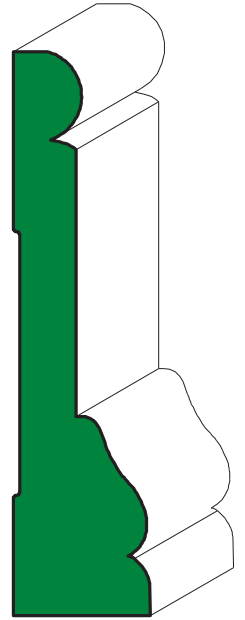

SMITHWYCK
3/4 x 2 15/16
WF, FJ

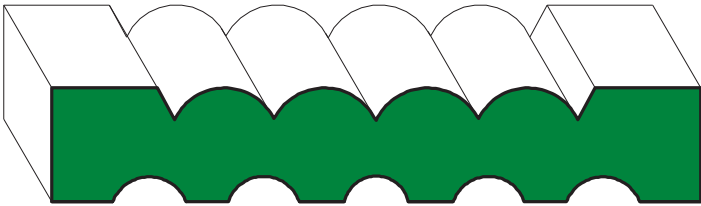

LRM 338 Reeded / Fluted
5/8 x 3 3/8
MDF

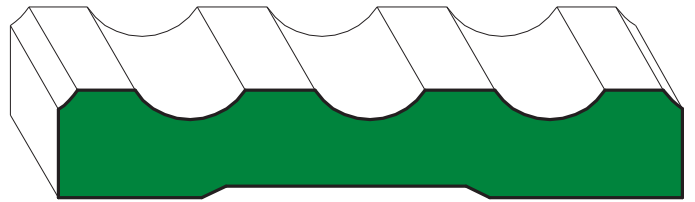

LRM FC3
9/16 x 3 1/4
WF, FJ

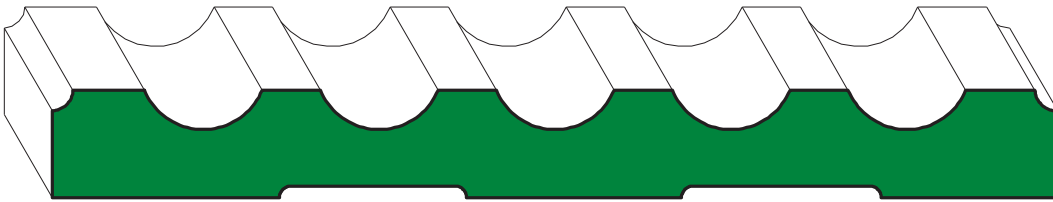

LRM FC5
9/16 x 5 1/4
WF, FJ

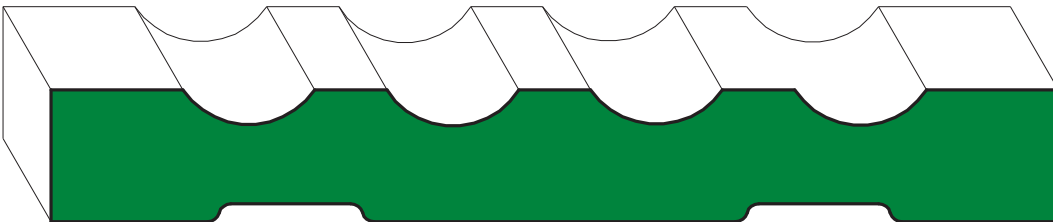

LRM NH116
11/16 x 5 1/4
FJ

CLASSIC ROSETTES
WHITE PINE, MDF

PLINTH BLOCKS
WHITE PINE, MDF

CASINGS & BASES

TRADITIONALLY USED AS A BASE CAN BE USED FOR A WIDER CASING

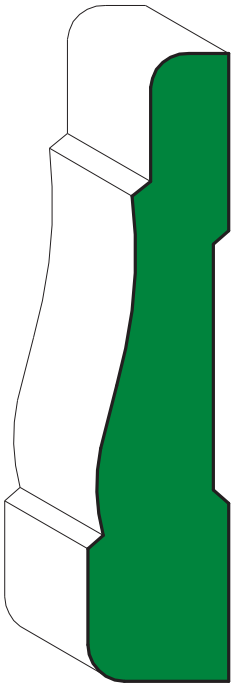

LRM 444EE
11/16 x 3-1/4
FJ

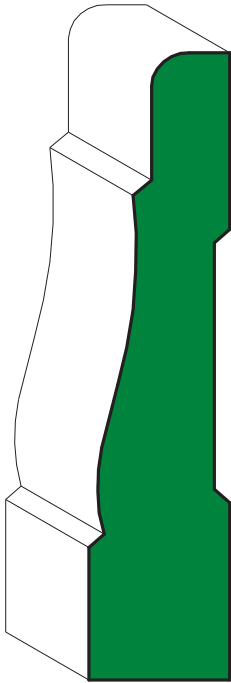

LRM 444
11/16 x 3-1/4
WF, FJ, PM, MDF
FJ 7'3"

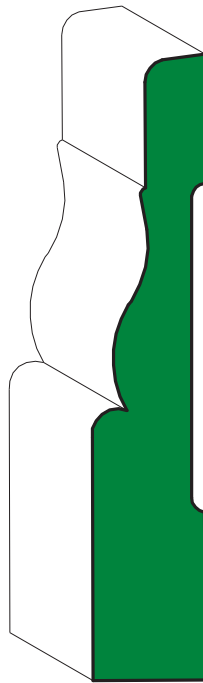

LRM RM444
11/16 x 3-1/4
WF, FJ, PM

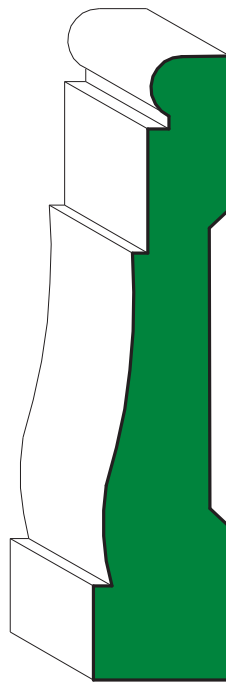

LRM 445
11/16 x 3-1/4
WF, FJ, FJ 7'3"

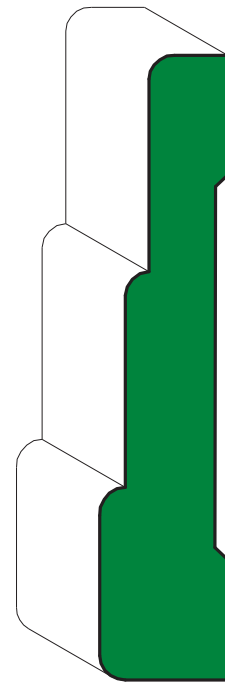

LRM 683
5/8 x 3-1/4
WF

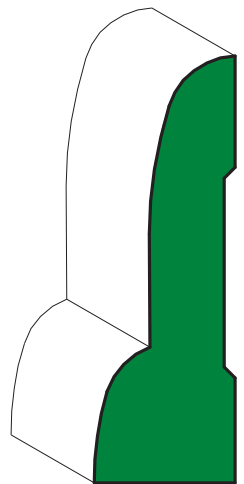

LRM 795
11/16 x 2-1/4
WF

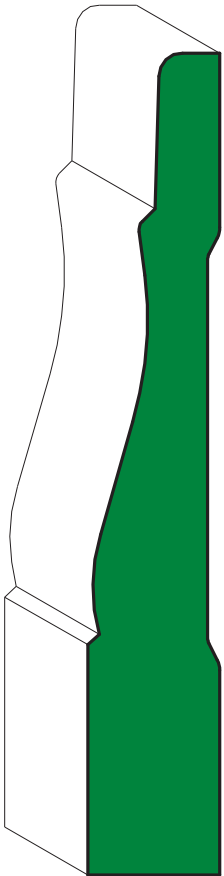

LRM L444
11/16 x 4-1/4
FJ

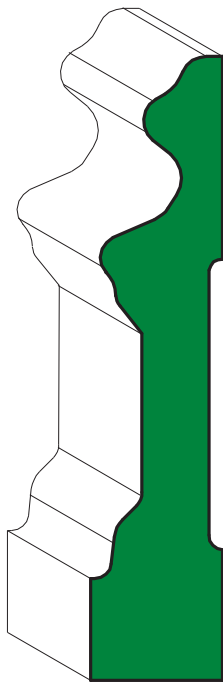

CHARLESTON BASE
11/16 x 3-1/4
WF, FJ

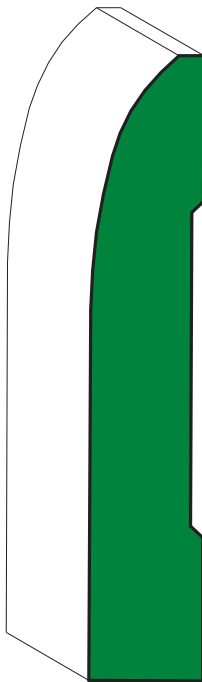

LRM 713
9/16 x 3-1/4
WF, FJ, PM

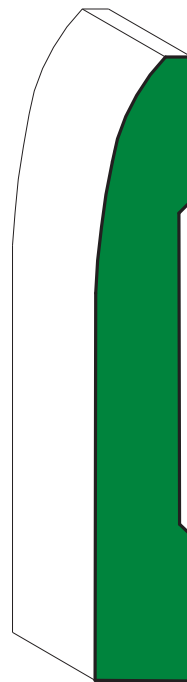

LRM 723
7/16 x 3-1/4
WF, FJ

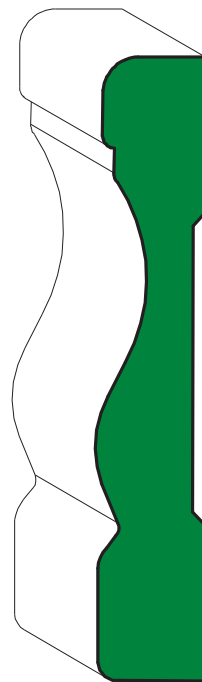

LRM A BASE
9/16 x 3-1/8
WF, FJ

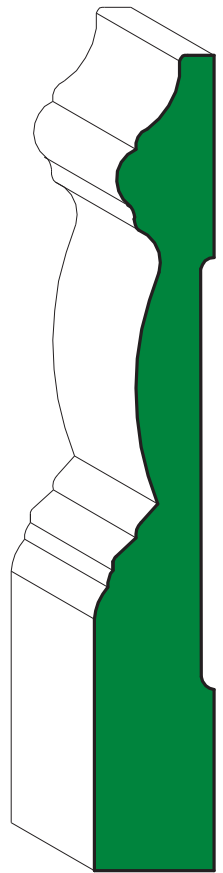

LRM HILINE BASE
5/8 x 4-1/4
FJ

WF - SOLID WHITE FIR STAIN GRADE
FJ - FINGER JOINT PAINT GRADE
PM - PRIMED FINGER JOINT PAINT GRADE
MDF - PRIMED MEDIUM DENSITY FIBERBOARD

BASES

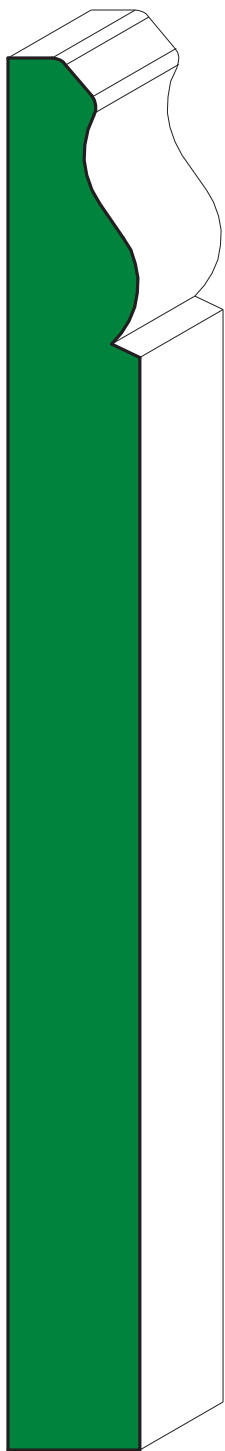

LRM 163 E-7
11/16 X 7-1/4
MDF

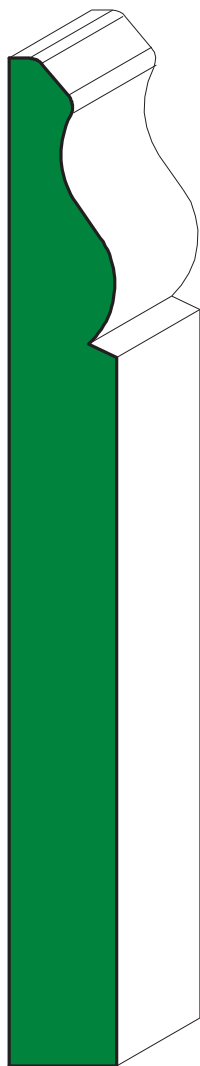

LRM L163 E-5
9/16 X 5-1/4
MDF



CANDLELITE BASE
9/16 x 5-1/4
FJ

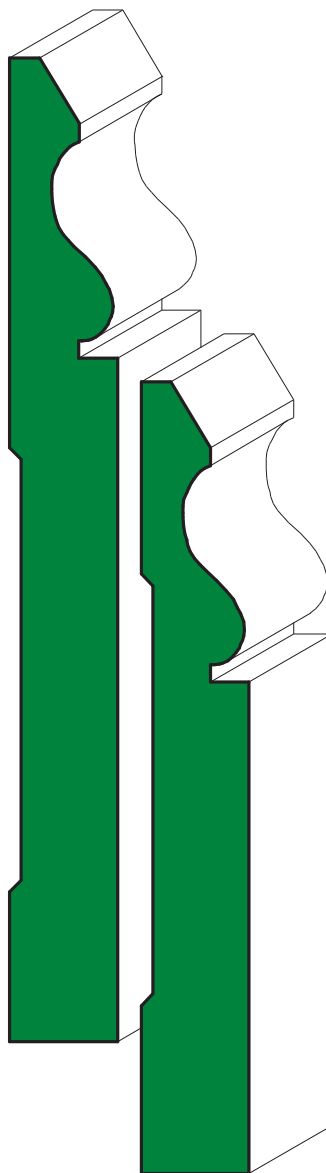

WOODARD BASE
9/16 x 5-1/8
WF, FJ, PM

WOODARD BASE
9/16 x 4-1/8
WF, FJ



LRM 218
9/16 X 5-1/4
MDF

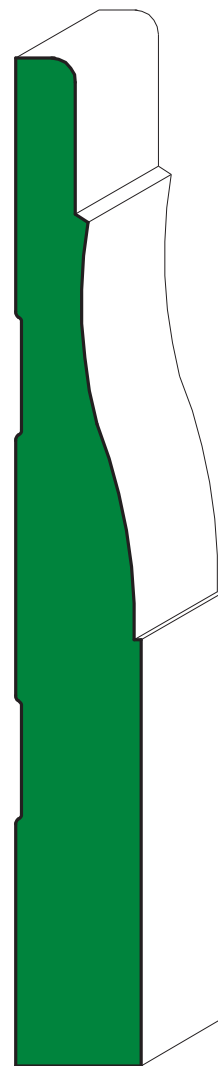

LRM XL444
11/16 X 5-1/4

BASES

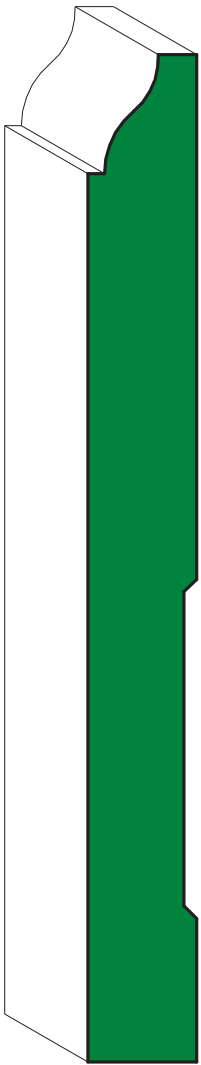

LRM 618
9/16 X 5 1/4
WF, FJ, PM, MDF

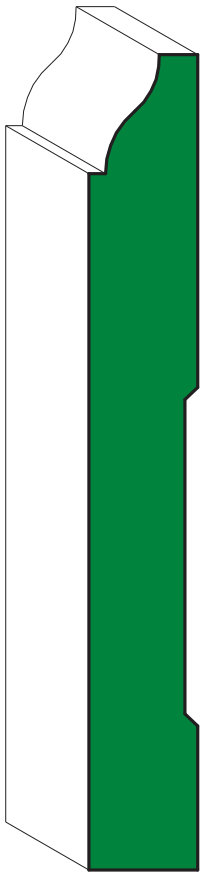

LRM 620
9/16 X 4 1/4
WF, FJ, PM, MDF

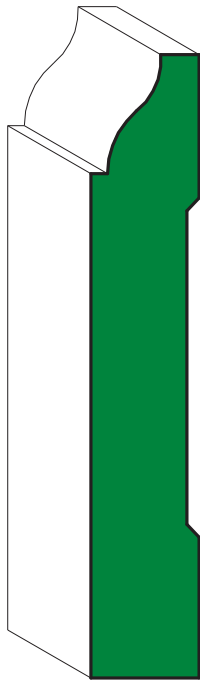

LRM 623
9/16 X 3 1/4
WF, FJ, PM, MDF

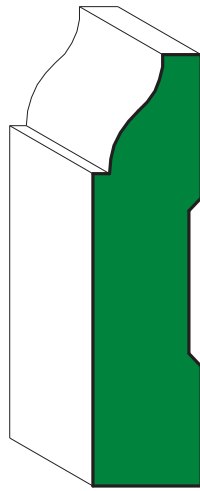

LRM L623
9/16 X 2 1/4
FJ

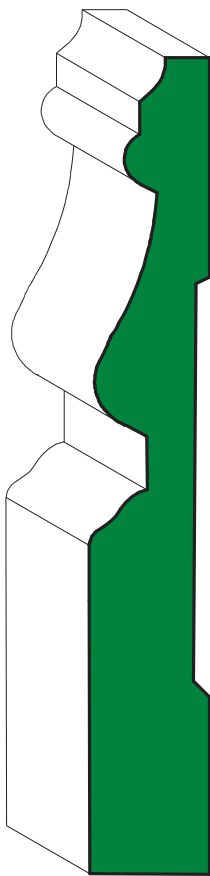

LRM 3242
9/16 x 4-1/4
WF, FJ

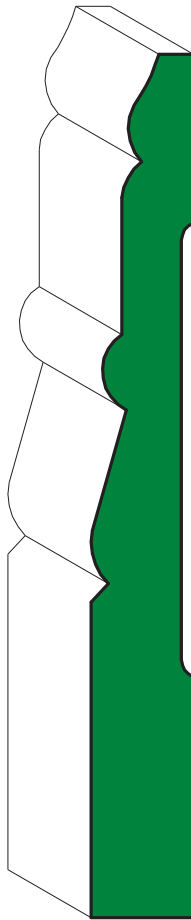

LRM 11B
9/16 X 4 1/2
MDF

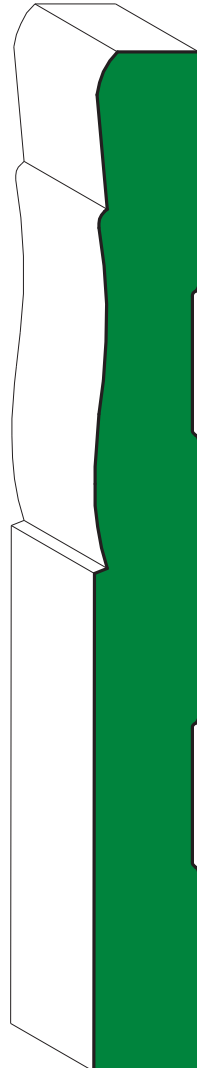

LRM RM-L444
9/16 x 5-1/4
FJ

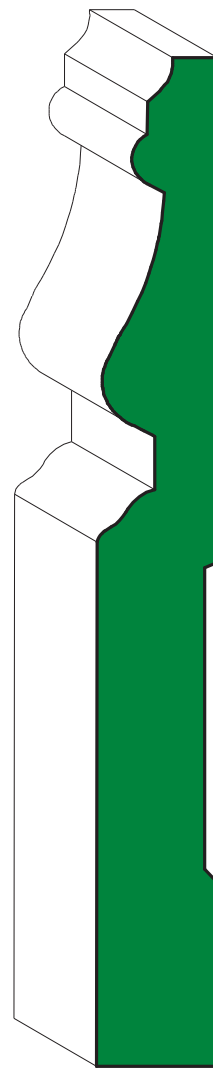

LRM L3242
9/16 x 5-1/4
WF, FJ

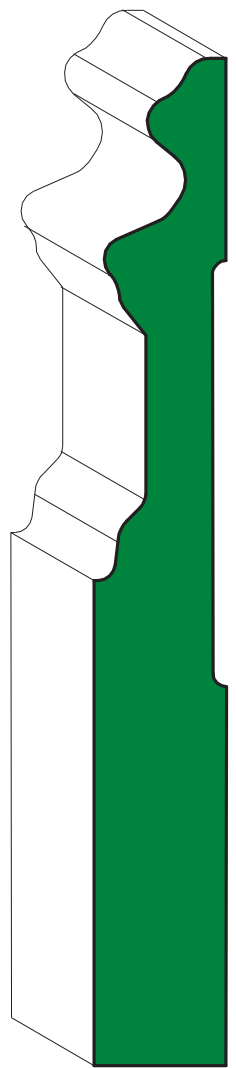

CHARLESTON BASE
11/16 x 5-1/4
WF, FJ

DOOR TRIM

STOPS

In door trim, Stop is nailed to the faces of the door frame to prevent the door from swinging through. As window trim, stop holds the bottom sash of a double-hung window in place.



LRM 876 7/16 x 1-3/8
WF R, 7', 7'3" FJ R, 7', 7'3", 8'3"

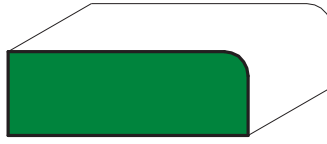

LRM 877 7/16 x 1-1/4
WF, FJ, MDF WF 7', FJ 7'

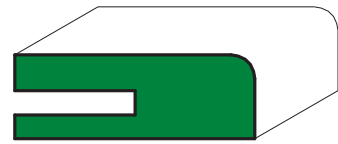

LRM 877 KERFED
7/16 x 1-1/4 FJ

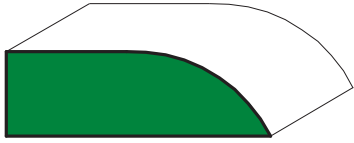

LRM 816
7/16 x 1-3/8 WF, WF 7'

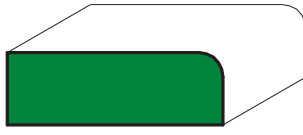

LRM 888 3/8 x 1-1/8
WF, FJ FJ 7', 7'3", 8'3"

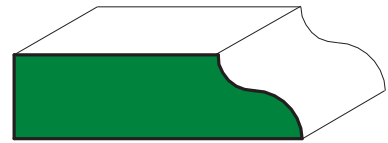

LRM 906
7/16 x 1-3/8 WF, WF 7'

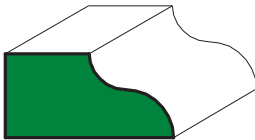

LRM 910
7/16 x 7/8 WF

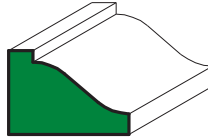

LRM L941
7/16 x 5/8 WF

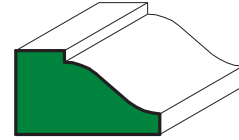

LRM 941
7/16 x 3/4 WF

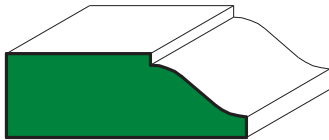

LRM 937
7/16 x 1-1/4 FJ

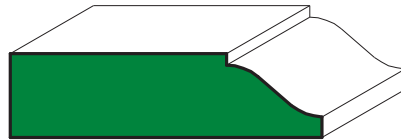

LRM 935
7/16 x 1-5/8 FJ

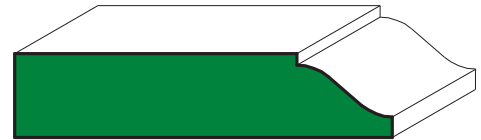

LRM L933
7/16 x 2 WF

BRICK MOULD

Used as an exterior door & window casing. A thick moulding providing a surface for brick or other siding to butt against.

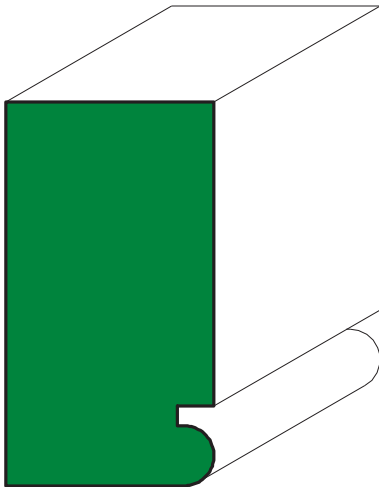

LRM 175
1-1/16 x 2
WF, FJ

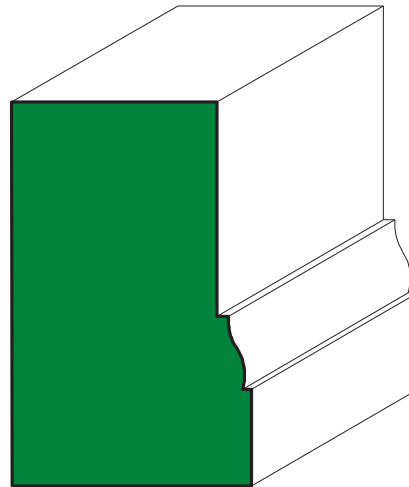

LRM 180
1-1/4 X 2
WF, WF-7', FJ, FJ-7', PM

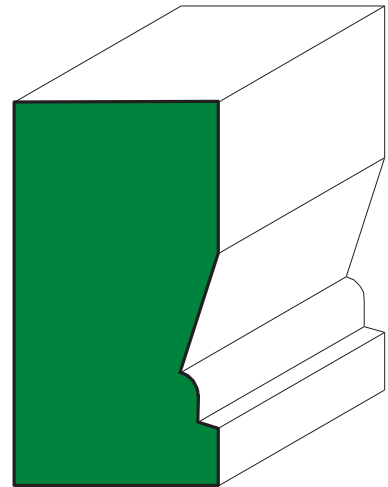

LRM KOLBE
1-1/16 X 2
WF, FJ

DOOR TRIM

JAMBS

INTERIOR SPLIT JAMBS

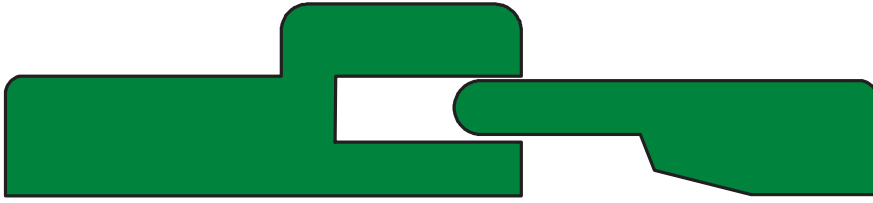

11/16 x 4-9/16 WF, FJ

INTERIOR FLAT JAMBS



11/16 x 4-9/16 WF, WV, FJ, MDF
11/16 x 5-1/4 WF, WV, FJ
11/16 x 6-9/16 WF, WV, FJ

INTERIOR FLAT JAMBS WITH TRIM GUIDES



11/16 x 4-9/16 FJ

FRAMES

EXTERIOR FRAME KERFED FOR WEATHERSTRIPPING



1-1/4 x 4-9/16 WF, FJ
1-1/4 x 5-1/4 WF, FJ
1-1/4 x 6-9/16 WF, FJ

EXTERIOR FRAME



1-1/4 x 4-9/16 WF, FJ
1-1/4 x 5-1/4 WF, FJ
1-1/4 x 6-9/16 WF, FJ

T-ASTRAGALS

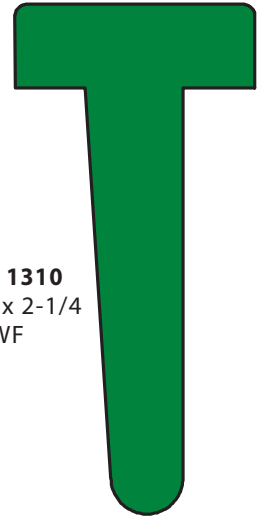

LRM 1310
1-1/4 x 2-1/4
WF

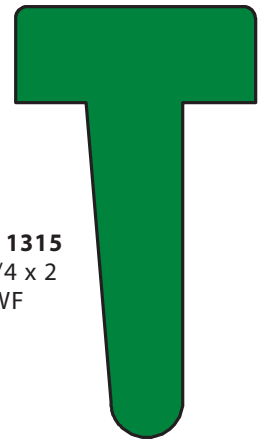

LRM 1315
1-1/4 x 2
WF

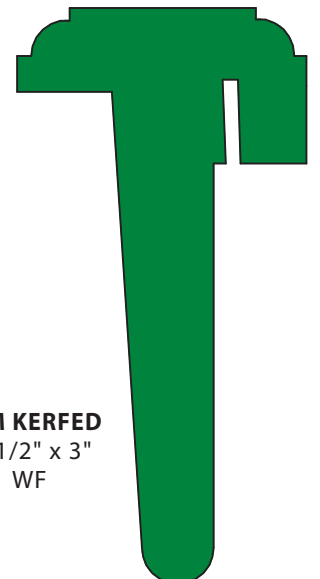

LRM KERFED
1-1/2" x 3"
WF

MOULDING COMBINATIONS

Whether a large crown, a unique chair rail, or just a different look, combining moulding profiles in create the possibilities. Combining standard profiles in different combinations can give you the depth and creativity. Combining casings and bases with crowns can create patterns that you could not find in a single profile. Tall, ornate bases, detailed casing, impressive chair rails, even fireplace mantels can have that special look.

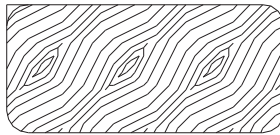

BEAM DETAIL OR BOXED CROWN

- A - LRM 52 CROWN
- B - LRM S45-6
- C - LRM BEAM BEAD
- D - LRM S45-4

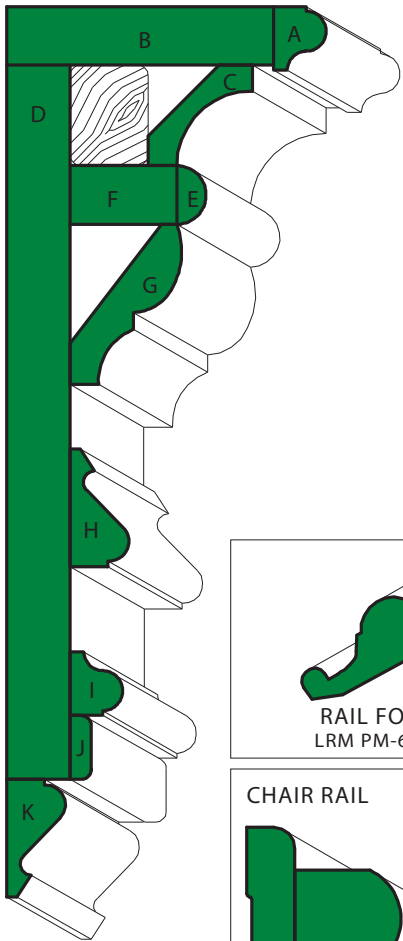
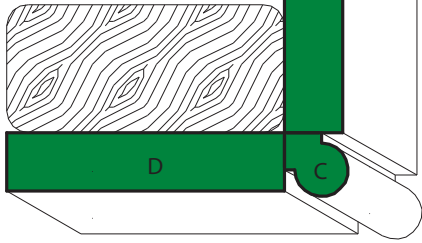

STACKED CROWN

- A LRM 172
- B LRM S45-4
- C LRM 85
- D LRM S45-6
- E LRM 122
- F LRM 251
- G LRM 72
- H LRM 163
- I LRM 172
- J LRM 142
- K LRM 163

CHAIR RAIL

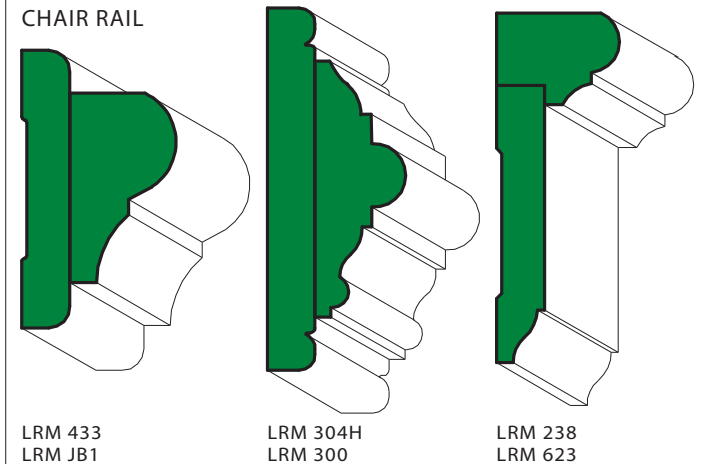

CROWN COMBINATIONS

LRM L623
LRM COVE CROWN

CHARLESTON BASE
CURTIS CROWN

CAPITAL
A LRM 122
B LRM 248
C LRM S45-6
D LRM 72
E LRM NOSING

LRM RC CROWN
LRM HILINE 4

CASINGS WITH BACK BANDS

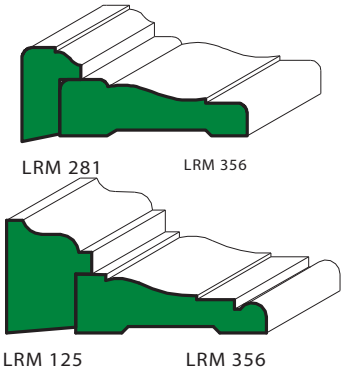

BASE COMBINATIONS

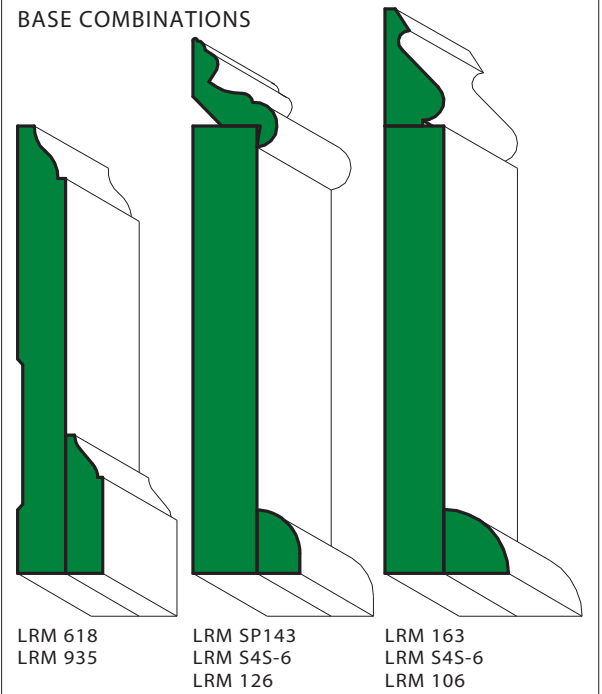

RAIL FOR LAWYER'S PANELING WAINSCOT
LRM PM-6 LRM S45-4 LRM PM-6

When installing the different pieces of the combined profile, it is better to completely install the first piece for the whole project, then add the second piece of the combination and then move on to the third piece, and so on. It is much easier to measure, cut and miter each piece as you come to it rather than construct the combined profile and then do the mitering. With such a large unit, there would be more margin for error.