



Your home is a reflection of your unique style and taste... make a lasting impression with Kaycan siding and accessories.



ELEGANCE



SIERRA



LEWISTON



T-3 WOOD GRAIN



CLASSIC

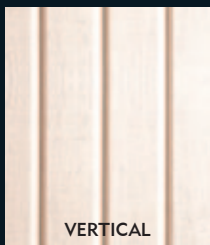

VERTICAL

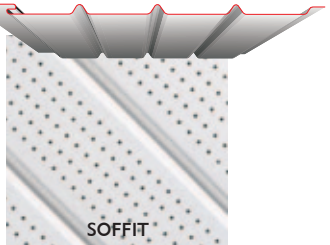

SOFFIT

For the best results guaranteed, *Kaycan* products are backed by the most comprehensive **No-Nonsense Limited Lifetime Warranty**. Your *Kaycan* vinyl siding is protected against peeling, flaking, blistering, denting; is stain resistant and never needs repainting.

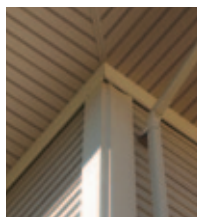

Kaycan offers a wide selection of exterior home building products with the same built-in beauty and protection as their vinyl siding: Soffits, Kaytec™ Windows, Shutters, Aluminum Soffit and Siding, Aluminum Gutters and Downspouts, Gable Vents and Mounting Blocks.

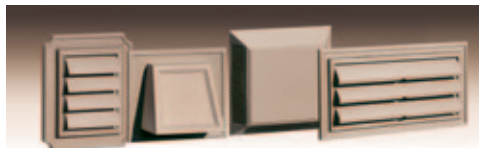
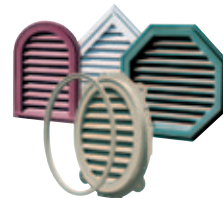

**Important:** Colors shown may differ slightly due to printing techniques. Please refer to actual color chips for accurate color representation.

**KAYCAN**

[www.kaycan.com](http://www.kaycan.com)

1-800-952-9226

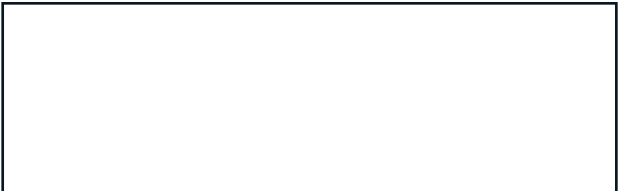

VSPam-EW ©2010 Kaycan

# Vinyl Siding



**KAYCAN**

BUILDING LASTING IMPRESSIONS

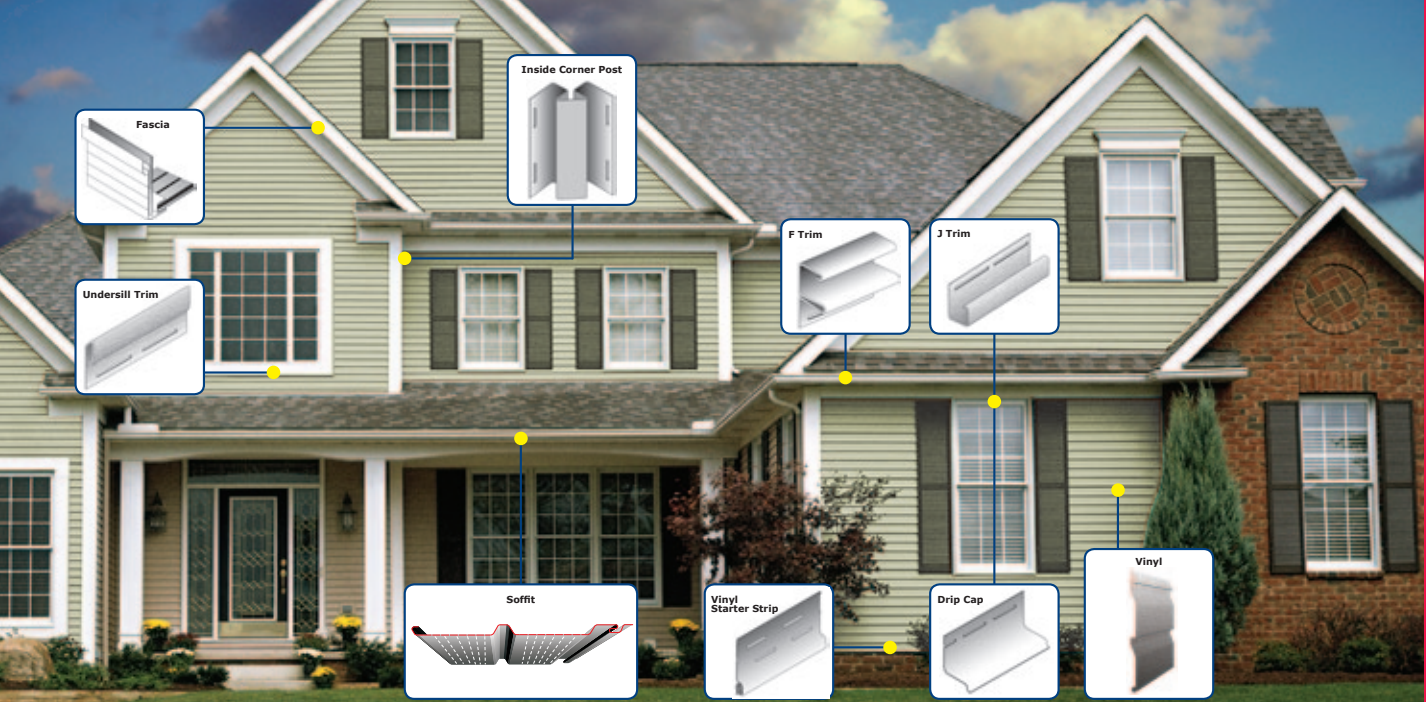

**KAYCAN**

BUILDING LASTING IMPRESSIONS

Kaycan's high performance, superbly crafted vinyl siding and accessories are designed with unsurpassed strength, durability and worry-free maintenance for **the ultimate in beauty and protection for your home.**

*it's about beauty*

Low gloss finish of Kaycan's exclusive Duratron™ Vinyl Formula, realistic wood grain texture, deep shadow lines and infused-color throughout the panel give the **closest appearance and feel of natural wood**, virtually maintenance-free.

**A limitless choice** of designer colors, accent trims, soffit and accessories that match the strength, natural look and maintenance-free durability of Kaycan vinyl siding.

*it's about protection*

Patented Duratron™ Vinyl Formula combines 11 of the **highest quality ingredients with state-of-the-art technology** for lasting performance in all types of environments.

Exclusive Secure™ locking system **firmly locks panels together** for the greatest rigidity and stability.

*it's about trust*

**For more than four decades** Kaycan has been the trusted name in home siding and accessories by continuing to deliver incomparable product performance and exceptional quality care.

**Duratron™**

The secret to Duratron's™ success is combining the highest quality ingredients before even starting production for built-in strength, durability and brilliant color throughout the panel.



- **Virgin PVC Resin**  
for strength, stability and rigidity
- **Impact Modifiers**  
to prevent dents and cracks
- **Titanium Dioxide**  
for 100% UV protection for fade resistance and color retention
- **Stabilizers**  
to protect the panel from deterioration in all weather conditions
- **Low Gloss Finish**  
for the natural look of freshly painted wood
- **Designer Choice Pigments**  
for a beautiful color that won't scratch or fade

**EXCEEDS NATIONAL BUILDING STANDARDS for impact, expansion and contraction...**

So your Kaycan siding will stand up to the worst Mother Nature can deliver.

All Kaycan products are put through a variety of rigorous testing by an independent testing laboratory and meet or exceed North American building codes: IBC, IRC, UBC, BNBC, SBC and NBC (National Building Code of Canada).

Regulatory compliance: ICC Evaluation Report ESR-1495, Conforms with UBC Standard 14-2, VSI Certified - Conforms to ASTM D3679, Evaluation Listing CCMC 11814-L and 12783-L - Conforms to CAN/SGSB 41.24, Florida Building Code 2007 Approved, Miami-Dade Product Control Approved.

# TRIMS AND APPLICATIONS



**KAYCAN**

*Infinite trim and accessory options*

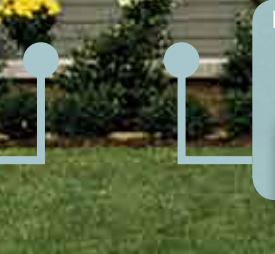

# General and Starter Trims

**1 Starting a Wall**  
How to use the starter strips.

**2 Using a dual undersill trim**  
How to use the dual undersill trim.

**3 Using a vertical base trim**  
How to go from one section to the other.

**4 Finishing a wall with J Trims**  
How to use J Trims.

**5 Using double J Channels**  
How to use double J Channels to join two sections of walls.

**6 Finishing Trims**  
How to use finishing trims around walls.

## A good start for a great finish

A great finish begins with a good start. That's why Kaycan Starter Trims are the best choice for securing the first course of siding panels to the home. Kaycan's variety of J, H, Vertical Base, Undersill and J Trims provide the perfect finishing touch to your design.

**1** Application of Vinyl Starter Strip



**2** Application of Dual Undersill Trim



**3** Application of Base Trim



**4** Application of J Trim to Bottom



**6** Application of J Trim to Side



**5** Application of Double J Channel and Undersill Trim



Application of Kaylock Starter Strip

**Undersill Trim**  
(1066)

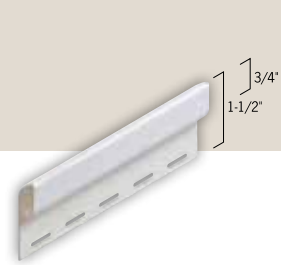

Used to secure a cut vinyl siding panel underneath the bottom of a window and the top sheet on the house wall.

**Dual Undersill Trim**  
(VT2DUU)

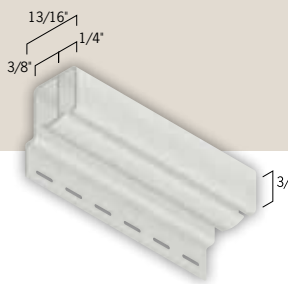

Used to secure a cut vinyl siding panel as per the Undersill Trim. Double slot accepts a bevel or a dutch lap siding panel.

**Vertical Base Trim**  
(1175)

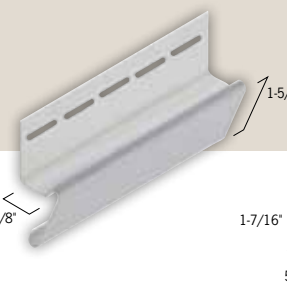

5/8" deep trim with a 1 5/8" face. Used for transition from horizontal to vertical siding. The vertical base trim locks to the horizontal siding.

**5/8" J Trim**  
(1035)

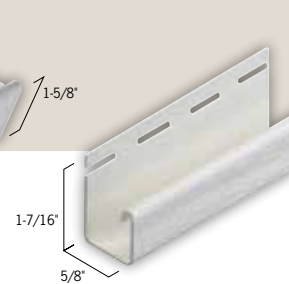

5/8" deep trim with a 3/4" face. This is the standard trim used around doors and windows. DaVinci 5/8" J Trim (1034). Hardwood Valley II 5/8" J Trim (VJB58HV).

**1 1/4" J Trim**  
(1045)

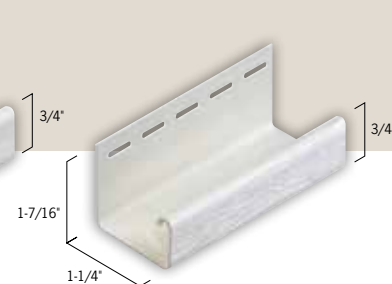

1 1/4" deep trim with a 3/4" face. Used for deeper profiled siding or when insulation is being used behind the siding.

**1 5/8" J Channel**  
(1059)

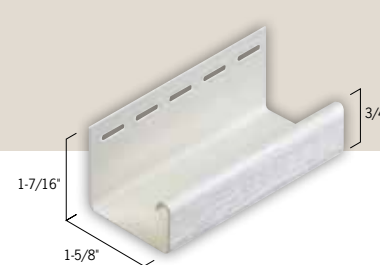

1 5/8" deep trim with a 3/4" face. Used when insulation is behind the siding.

**Double 3 1/2" J Channel**  
(106201)

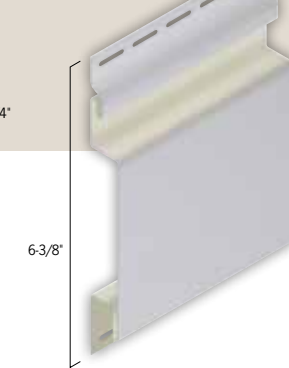

"Belly trim" with 3 1/2" face and a built in "J". Used as a 3 1/2" band in a horizontal siding wall.

**Double 6" J Channel**  
(106301)

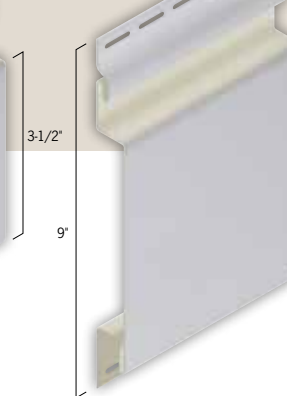

"Belly trim" with 6" face with built in "J". Used as a 6" band in a horizontal siding wall.

**Vinyl Starter Strip**  
(1085)

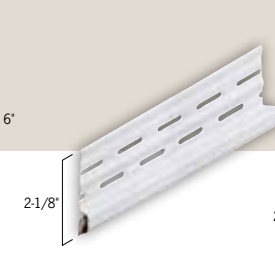

Starter strip is used to lock the first row of siding in place. This starter strip offers a positive lock.

**Kaylock Starter Strip**  
(1082, 1083)

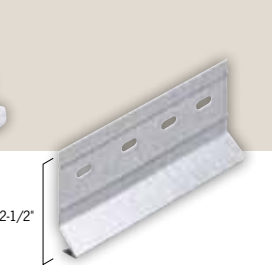

Metal starter strip is used to lock the first row of siding in place. These starter strips offer a snap lock.

# Corner Post Trims

**1 Standard Corner Post**  
How to use the standard corner post.

**2 2-Piece Corner Post**  
How to use the 2-piece corner post.

**3 Inside Corner Post**  
How to use the inside corner post.

**4 5-Piece Cove Corner Detail**  
How to use all trims to create the cove corner detail.

*From ordinary to extraordinary*

Transform an ordinary corner into a distinctive design element with Kaycan's Outside/Inside Corner Post and Corner Trims.

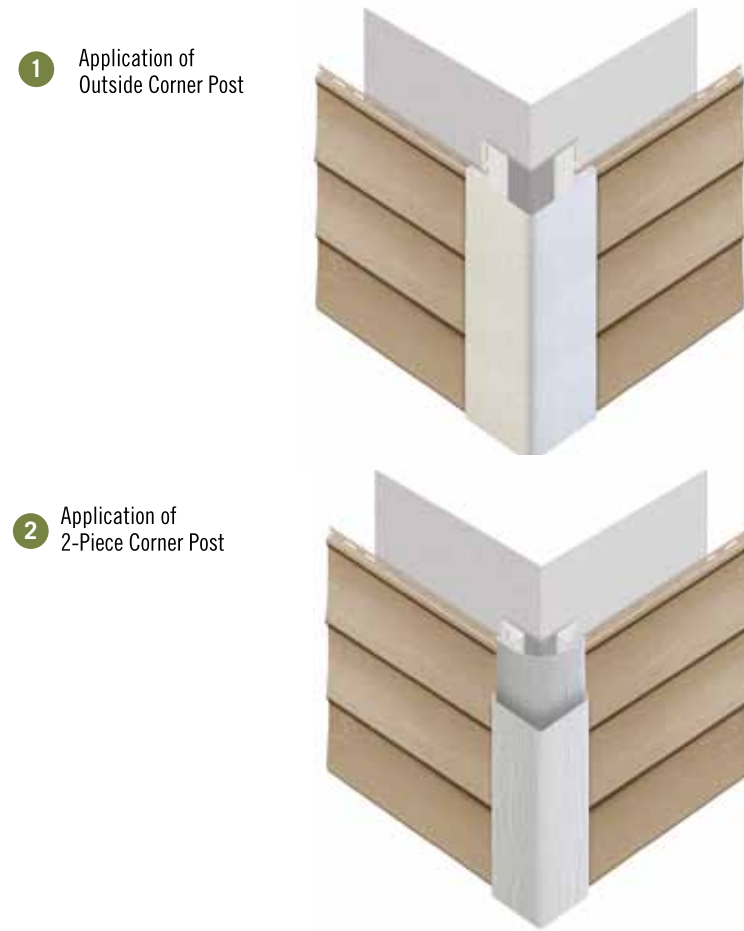

**3" Outside Corner Post** (1105)



Corner piece with two 3" faces and two 3/4" wide channels to insert siding. DaVinci™ siding corner post (1098).

**4" Outside Corner Post** (1104)

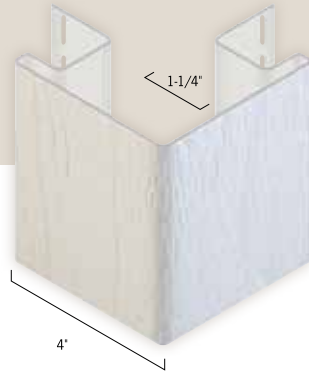

Corner piece with two 4" faces and two 1 1/4" wide channels to insert Ocean Park™ siding. 4" corner piece for 1 1/2" wide channels.

**6" Designer Corner Post** (1107)

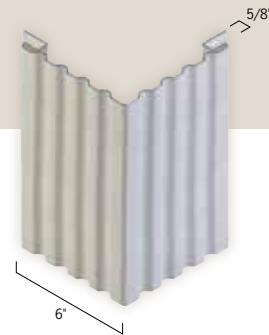

Corner piece with two 6" ribbed faces and two 3/4" wide channels for siding.

**6" Traditional Corner Post** (1250)

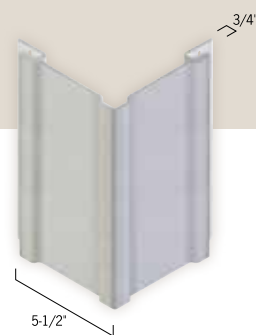

Decorative corner piece with two 6" faces with setbacks and two 3/4" wide side channels for siding.

**Inside Corner Post** (1115)

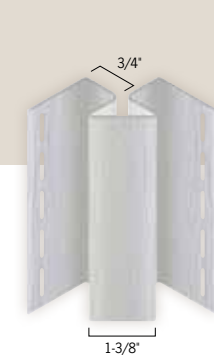

Inside corner post with one 3/8" face and two 5/8" wide channels for siding.

**2-Piece Corner Post** (Base-1239)(Cap-1240)

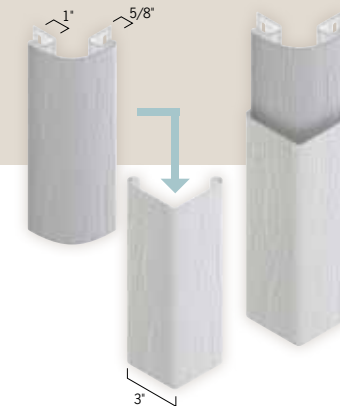

Base corner piece with two 5/8" wide channels for siding. Corner Cap installs over the base and has two 3" faces.

**5-Piece Cove Corner Detail** (1053, 1054, 1055)



Cove corner made with five trims. Two starter trims (1054), two 5" surround trims (1055) with one Corner Cove Insert (1053). Used together to produce a different and interesting cove corner detail.

**Bay/Bow Outside Corner Post** (1174)



Corner piece with two 5/8" wide channels for siding. Used when installing siding with bay or bow windows.

**Bay/Bow Inside Corner Post** (1173)



Inside corner piece with two 5/8" wide channels for siding. Used when installing siding with bay or bow windows.

**1 Soffit Installation with Trims**  
How to install soffit using F Trims.

**2 Using an H Trim**  
How to join two sections of a wall or soffit.

**3 Exterior Vinyl Fascia Use**  
How to use vinyl fascia with soffit.

**4 Exterior Aluminum Fascia Use**  
How to use aluminum fascia with soffit.

**5 Exterior Aluminum Fascia Use**  
How to use aluminum fascia with soffit.

**6 Exterior Aluminum Fascia Use**  
How to use aluminum fascia with soffit.

## Add form and function

Whether it is to add a decorative finish, start the soffit installation, or to help take water away from the wall, Kaycan Sofft Trims help add design and functionality to any home.

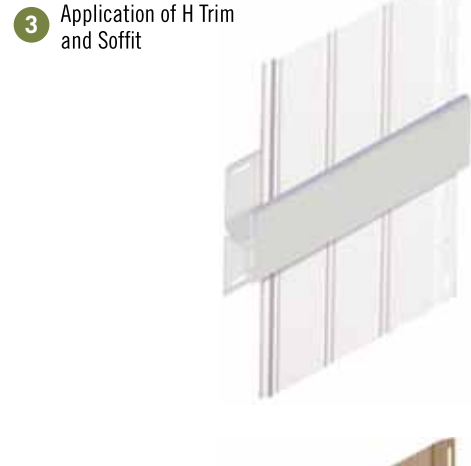

**F Trim**  
(1178)

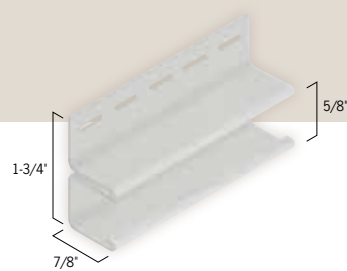

Trims with a 5/8" wide channel, used at the top of the wall and on the bottom of the fascia board to insert soffit.

**H Trim**  
(1179)

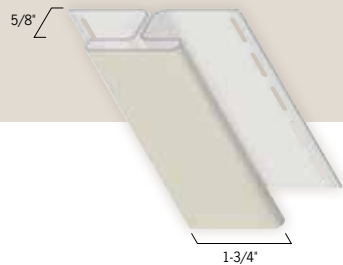

Used to add a break in a wall or ceiling of vertical siding and soffit.

**Soffit Crown Mount**  
(1220)

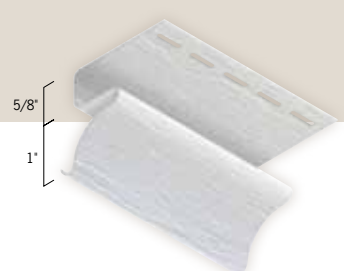

This trim is used as a soffit J Trim on top of walls to add a decorative finish under the soffit.

**8" Vinyl Fascia**  
(0490)

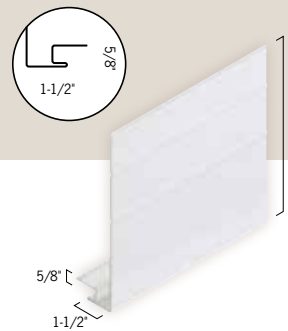

8" vinyl fascia used to finish the exterior of the structure with integrated 5/8" wide channel for soffit. The fascia can be cut down to fit various structure heights.

**4", 6", 8" and 10" Ribbed Aluminum Fascia**  
(0495, 0480, 0481, 0535)

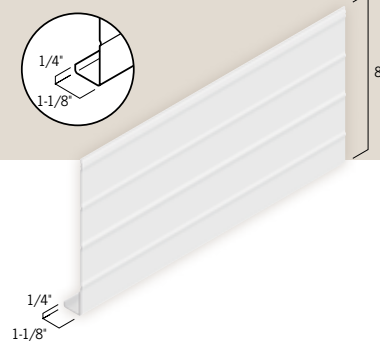

Aluminum ribbed fascia used to finish the exterior of the structure.

**Frieze Trim**  
(VTFBR)

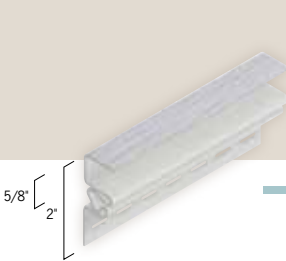

Can be used in combination with the Large Crown Mold. The top channel of the frieze is designed to accommodate the soffit, while the Large Crown Mold snaps into the bottom channel and covers the top of the siding wall and undersill trim.

**Large Crown Mold**  
(VTCMD)



Used in combination with the Frieze Trim, it snaps into the bottom channel of the Frieze Trim and covers the top of the siding wall and undersill trim.

## Enhancing architectural appeal

Kaycan Window Trims enhance the beauty and add a decorative accent to windows.

### 1 Finishing Windows with J Trims

How to use J Trims around windows. The detail shown is for the bottom of the window.

### 2 Window Detail with Drip Cap and J Trim

How to use J Trims and drip cap on top of a window.

### 3 Window Surround used around a Window

How to use the window starter trim with the window surround trims.

### 4 Flexible J Trim Use

How to use the Flexible J Trim to finish a rounded window.

1 Application of J Trim and Undersill Trim



2 Application of Drip Cap and J Trim



3 Application of Window Starter and Window Surround



4 Application of Flexible J Trim



**Super J Trim**  
(1056)

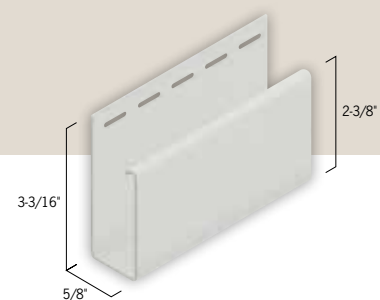

Trim used to create architectural details around doors and windows.

**3 1/2" Window Surround**  
(1052)



Trim used with the window starter trim to create a wide band around windows.

**5" Window Surround**  
(1055)

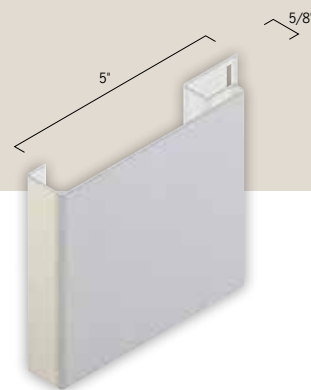

Trim used with the window starter trim to create a wide band around windows.

**Window Starter**  
(1054)



Trim used to anchor window surround trims.

**Undersill Trim**  
(1066)

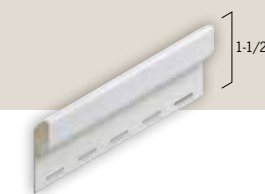

Used to secure a cut vinyl siding panel underneath the bottom of a window and the top sheet on the house wall.

**Drip Cap**  
(1185)

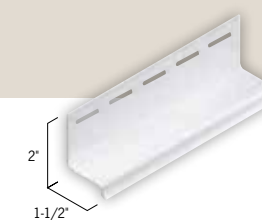

Trim used over windows to allow water to flow away from the wall.

**5/8" Flexible J Trim**  
(2095)

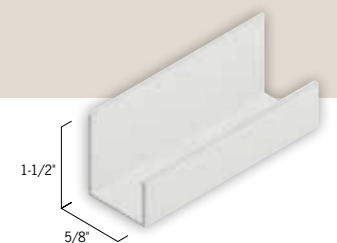

Trim used around window tops and shaped windows.



*The perfect accent makes the perfect home.*

As one of North America's largest manufacturers of siding profiles and accessories, Kaycan is renowned for offering a vast array of innovative, long-lasting and low maintenance products. Our accessories, accent products and trims offer the perfect finishing touch for the look you've always imagined.

*Kaycan... Building Lasting Impressions.*

Built on more than 40 years of experience, all our Kaycan vinyl siding and accessories are designed to last for decades. Kaycan has got you covered as all our products are backed by a limited lifetime warranty.



**KAYCAN**

All Kaycan vinyl sidings and accessories are backed by a lifetime Limited Warranty.

[www.kaycan.com](http://www.kaycan.com)

TABROEng - 11A @Kaycan

