



Deck Connection and Fastening Guide



RECOMMENDATIONS FOR THE CONSTRUCTION OF CODE-COMPLIANT DECKS

Contents

Introduction — Improperly Built Decks Can Be Dangerous	3
Code Concerns	4
Critical Deck Connections	5
Existing Decks: Retrofit or Replace	6–7
Ledger Attachment	8
Lateral Load Connection	9
Footings	10
Post Bases	11–12
Beam-to-Post Connections	13
Joists Terminating into Beam/Ledger	14
Joists Bearing on a Beam	15
Railing Post-to-Deck Framing	16
Stair Stringers & Treads	17
Selecting Connectors and Fasteners	18
Stainless-Steel Connectors	19
Correct Fasteners for Use with Simpson Strong-Tie Connectors	20
Structural Wood Fastening	21
Corrosion-Resistant Fasteners for Decking	22–23
Quik Drive Auto-Feed Screw Driving System for Decks	24
Color Match Fasteners for Composite and PVC Decking	25
EB-TY® and Fastener Finder	26
DeckTools® – Deck Sales and Design Software	27

Visit the Deck Center at
www.strongtie.com/deckcenter

Everything You Need in One Place

We have brought together all of our information and training on building stronger, safer decks in one location to make learning easier than ever.

A Word About Building Codes

This guide recommends connectors and fasteners for deck construction that may meet the requirements of the 2009/2012 International Building Code® and the 2009/2012 International Residential Code®. The information contained here is a summary of the requirements of these codes as they pertain to the connections highlighted in this guide. The building codes contain other requirements regarding aspects of deck

construction that are not addressed here, check the codes for details. Check with your local building department to verify what building codes have been adopted in your area.

Selection of products based upon performance and/or suitability for a specific application should be made by a qualified professional.

Simpson Strong-Tie recommends that deck designs are approved by the local building department before construction begins.

International Building Code and International Residential Code are registered trademarks of their respective organizations.

Limited Warranty

Simpson Strong-Tie Company Inc. warrants catalog products to be free from defects in material or manufacturing. Simpson Strong-Tie Company Inc. products are further warranted for adequacy of design when used in accordance with design limits in this catalog and when properly specified, installed, and maintained. This warranty does not apply to uses not in compliance with specific applications and installations set forth in this catalog, or to non-catalog or modified products, or to deterioration due to environmental conditions.

Simpson Strong-Tie® connectors are designed to enable structures to resist the movement, stress, and loading that results from impact events such as earthquakes and high velocity winds. Other Simpson Strong-Tie products are designed to the load capacities and uses listed in this catalog. Properly-installed Simpson Strong-Tie products will perform in accordance with the specifications set forth in the applicable Simpson Strong-Tie catalog. Additional performance limitations for specific products may be listed on the applicable catalog pages.

Due to the particular characteristics of potential impact events, the specific design and location of the structure, the building materials

used, the quality of construction, and the condition of the soils involved, damage may nonetheless result to a structure and its contents even if the loads resulting from the impact event do not exceed Simpson Strong-Tie catalog specifications and Simpson Strong-Tie connectors are properly installed in accordance with applicable building codes.

All warranty obligations of Simpson Strong-Tie Company Inc. shall be limited, at the discretion of Simpson Strong-Tie Company Inc., to repair or replacement of the defective part. These remedies shall constitute Simpson Strong-Tie Company Inc.'s sole obligation and sole remedy of purchaser under this warranty. In no event will Simpson Strong-Tie Company Inc. be responsible for incidental, consequential, or special loss or damage, however caused.

This warranty is expressly in lieu of all other warranties, expressed or implied, including warranties of merchantability or fitness for a particular purpose, all such other warranties being hereby expressly excluded. This warranty may change periodically – consult our website www.strongtie.com for current information.

Introduction



Summer brings deck danger to light

Construction problems can go unnoticed

When Don Bender and his team at Washington State University's Composite Materials and Engineering Center, they found that the deck is the most dangerous part of the house. Washington State Magazine's article Making Decks Safer reports "Decks cause more injuries and loss of life than any other part of the home structure."

More than a million decks are built and replaced each year in the United States. While decks are a popular feature of many homes, the construction and safety of decks have become a real concern within the building industry. Improper deck building has resulted in a growing number of deck failures and related injuries and deaths.

While decks are required to meet certain code standards and load capacities, it's estimated that of the 40 million existing decks, only half are code compliant — leaving 20 million decks that need to be rebuilt or retrofitted.

To help design and building professionals build code-compliant, safe decks, Simpson Strong-Tie has created this *Deck Connection and Fastening Guide*. This guide focuses on the critical connections involved in deck construction and what the code requires for these areas. It is intended to help designers, contractors, inspectors and do-it-yourselfers ensure that their decks are properly constructed per the International Building Code® (IBC) and International Residential Code® (IRC). The guide includes a complete deck connector system that covers all the hardware needs for deck construction and references the code to ensure it meets current requirements.



Improperly Built Decks Can Be Dangerous

More than a million decks are built and replaced each year in the United States. While decks are a popular feature of many homes, the construction and safety of decks have become a real concern within the building industry. Improper deck building has resulted in a growing number of deck failures and related injuries and deaths.

“ Decks cause more injuries and loss of life than any other part of the home structure. ”

—Don Bender, Director, Composite Materials and Engineering Center, Washington State University

According to Don Bender, the director of the Composite Materials and Engineering Center at Washington State University, the deck is the most dangerous part of the house. Washington State Magazine's article Making Decks Safer reports "Decks cause more injuries and

loss of life than any other part of the home structure. Except for hurricanes and tornadoes, more injuries may be connected to deck failures than all other wood building components and loading cases combined."

While decks are required to meet certain code standards and load capacities, it's estimated that of the 40 million existing decks, only half are code compliant — leaving 20 million decks that need to be rebuilt or retrofitted.

To help design and building professionals build code-compliant, safe decks, Simpson Strong-Tie has created this *Deck Connection and Fastening Guide*. This guide focuses on the critical connections involved in deck construction and what the code requires for these areas. It is intended to help designers, contractors, inspectors and do-it-yourselfers ensure that their decks are properly constructed per the International Building Code® (IBC) and International Residential Code® (IRC). The guide includes a complete deck connector system that covers all the hardware needs for deck construction and references the code to ensure it meets current requirements.

Code Concerns

Do Decks Really Need to Meet Code Requirements?

Because they look relatively simple to build, many people do not realize that decks are structures that need to be designed to adequately resist certain stresses. Like a house, or any other building, a deck must be designed to support the weight of people and objects placed on them, as well as lateral and uplift loads that can act on the deck as a result of occupant movement, wind or seismic activity. The 2009/2012 versions of both the IBC and IRC contain language outlining the general design requirements of structures. This excerpt from the 2009/2012 IRC (Section R301.1) represents a summary of the intent of both codes:

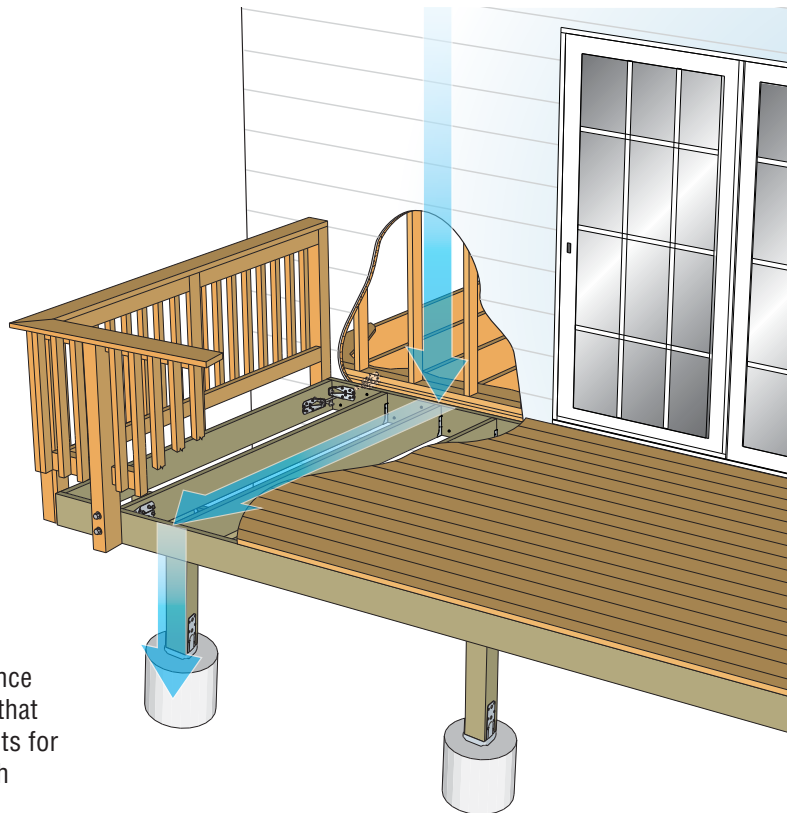

“The construction of buildings and structures in accordance with the provisions of this code shall result in a system that provides a complete load path that meets all requirements for the transfer of all loads from their point of origin through the load-resisting elements to the foundation.”

The concept of a complete or continuous load path refers to a series of solid connections within the structure of a deck that transfer load through its frame to the ground or adjacent, supporting structure (*commonly a building*). This same principle is applied to the design of all types of wood frame buildings. This continuous load path is created by using a system of structural connectors and fasteners to connect the wood members together.

Common Code Violations

The following code requirements can be easily overlooked in deck construction:

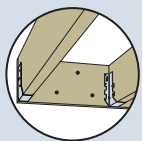

1. Proper fastening of the ledger connection

The building code prohibits the “use of toenails or nails subject to withdrawal” when making this connection, yet a number of deck failures result due to using these or other types of improper fasteners.

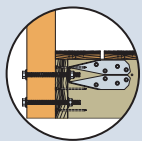

2. Proper fastening of guardrails to the deck

The IRC requires the guardrail to resist a 200-pound load. This load applied at the top of the guardrail, creates a large leverage force where the guardrail attaches to the deck framing.

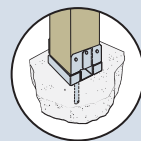

3. Post-base connections

The IRC requires posts “be restrained to prevent lateral displacement at the bottom end”. This requirement is important as most decks cannot safely support part or all of its structure, if a post is removed.

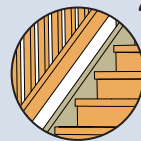

4. Openings in guards and stair railings

The building code places a limit on the size of openings, for the occupant’s safety in case of tripping or falling, or the safety of small children.

Critical Deck Connections

A system of key connections throughout the deck framing, also known as a continuous load path, is essential to building a safe, code-compliant deck. When this system of connections is made properly, loads are transferred throughout the deck's frame and into the ground and/or the adjacent structure to which the deck is connected.

The connections called out below are necessary in order to create an effective continuous load path.

For information on the inspection of existing decks, see page 7.

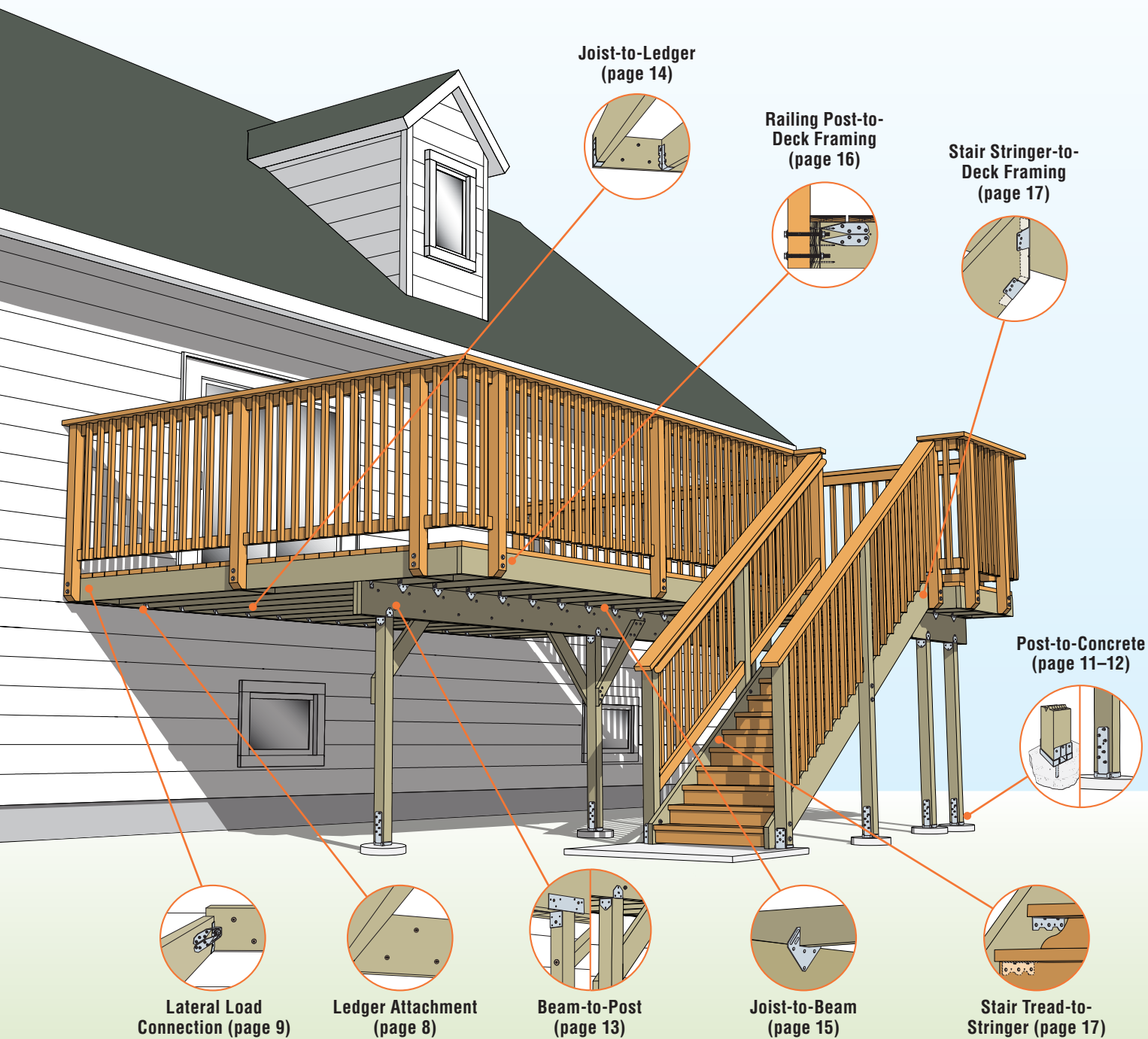

Existing Decks: Retrofit or Replace

Do I Need To Retrofit?

Retrofitting an Existing Deck

It is estimated that of the approximately 40 million existing decks, only half are code-compliant. Experts believe that it is likely that many of these decks are potentially unsafe. In situations where it is not feasible to rebuild an existing deck, it may be preferable to retrofit it by applying hardware to existing framing members. Many of the products shown in this guide may be installed after deck framing is in place and can improve the safety of the structure and help bring it within the requirements of the code.

The Life Expectancy of Decks

Most experts agree that the average life expectancy of a deck is 10 to 15 years. Since deck building started over 30 years ago, there are many existing decks that are past their useful life. Deck maintenance is often overlooked as well. Decks are exposed to the elements, which can cause damage. It's important that decks are properly inspected and maintained on a routine basis. If unsure it's best to consult with a professional, such as a structural engineer, architect, home inspector, or contractor in order to make sure the deck is safe.



Connector Solutions for Retrofitting

The following connectors are some of the products that may be suitable for deck retrofit. Selection of products based upon performance and/or suitability for a specific application should be made by a qualified professional. Simpson Strong-Tie recommends that deck designs be approved by the local building department before work begins.

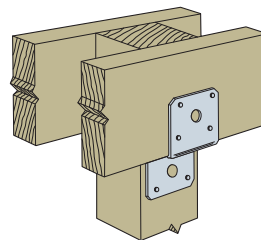

DJT: Connects beams at the side of the post.

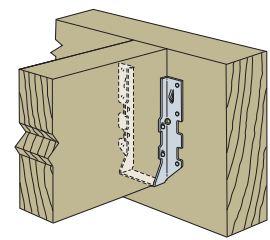

LUS Joist Hanger: Provides bearing and uplift resistance, features double-shear nailing for added strength.

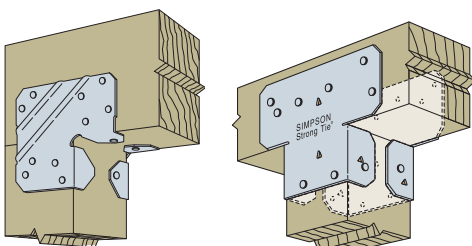

LCE/AC Retrofit Post Caps: Two-piece cap may be installed before or after lumber is in place.

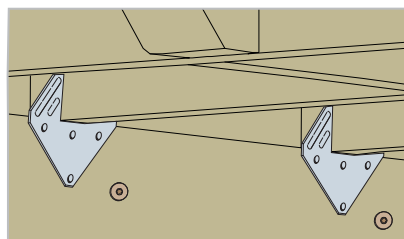

H1 Hurricane Tie: Holds joist on both sides.

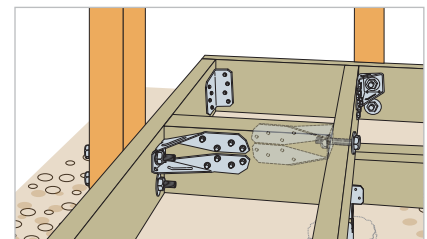

DTT Deck Tension Tie: Horizontal application fastening railing post to deck framing.

Existing Decks: Retrofit or Replace?

5 Things to Look for On an Existing Deck

When inspecting a deck to determine overall safety and compliance to building codes, look at the five areas below. Use this check list to help ensure a thorough evaluation.



Improper Connections

Any connections that do not meet the requirements discussed in this guide can compromise the safety of the deck. In many cases toenailing (i.e. joining two wood members with angled nailing) does not constitute a proper connection. Connectors must be installed with the correct fastener.

.....

.....



Loose Connections

Vital connections may have degraded over time. Wobbly railings, loose stairs and ledgers that appear to be pulling away from the adjacent structure are all causes for concern.

.....

.....

.....



Corrosion

Metal connectors and fasteners can corrode over time, especially if a product with insufficient corrosion resistance was originally installed. See page 18 for more information on corrosion.

.....

.....

.....



Rot

Wood can rot and degrade over time with exposure to the elements. Members within the deck frame that have rotted may no longer be able to perform the function for which they were installed.

.....

.....

.....



Cracks

As wood ages it is common for cracks to develop. Large cracks or excessive cracking overall can weaken deck framing members.

.....

.....

.....

Ledger Attachment

Code Requirements

✓ Where supported by attachment to an exterior wall, decks shall be positively anchored to the primary structure and designed for both vertical and lateral loads. Such attachment shall not be accomplished by the use of toenails or nails subject to withdrawal.

IRC 2009 Section R502.2.2
IRC 2012 Section R507.1
IBC 2009/2012 Section 1604.8.3

✓ For decks supporting a total design load of 50 pounds per square foot (40 pounds per square foot live load plus 10 pounds per square foot dead load), the connection between a deck ledger of pressure preservative-treated Southern Pine, incised pressure-preservative-treated Hem-Fir or approved decay-resistant species, and a 2-inch nominal lumber band joist bearing on a sill plate or wall plate shall be constructed with ½-inch lag screws or bolts with washers in accordance with Table R502.2.2.1 (IRC 2012 Table R507.2).

IRC 2009 Section R502.2.2.1
IRC 2012 Section R507.2

✓ Deck ledger connections not conforming to Table R502.2.2.1 (IRC 2012 Table R507.2) shall be designed in accordance with accepted engineering practice. Girders supporting deck joists shall not be supported on deck ledgers or band joists. Deck ledgers shall not be supported on stone or masonry veneer.

IRC 2009, Section R502.2.2.2
IRC 2012 Section R507.2.2

Selection of products based upon performance and/or suitability for a specific application should be made by a qualified professional. Simpson Strong-Tie recommends that deck designs be approved by the local building department before construction begins.

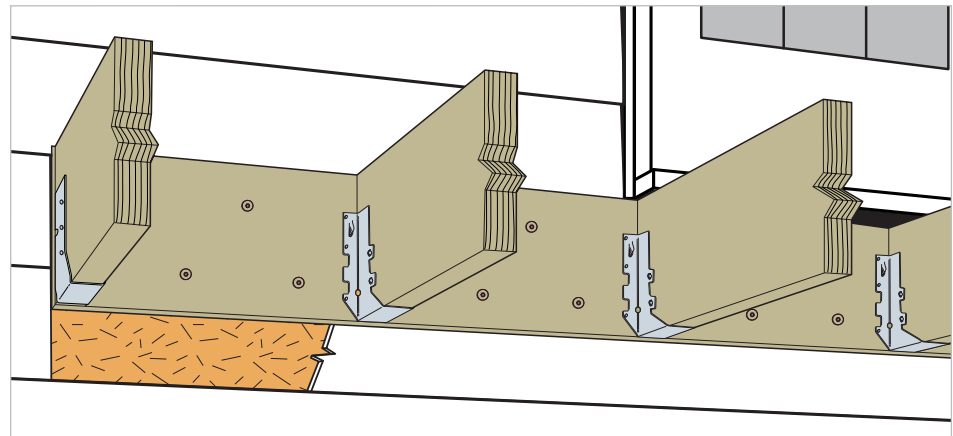

One of the most common causes for deck failure is ledgers that pull away from the primary structure, resulting in complete collapse.

The Simpson Strong-Tie Strong-Drive SDWS and SDWH structural wood screws provide an easy-to-install, high-strength alternative to lag screws and through-bolts. They are ideal for securely attaching ledgers to structural wood members, are easier to drive than comparable fasteners, and are coated for many exterior and preservative-treated wood applications.

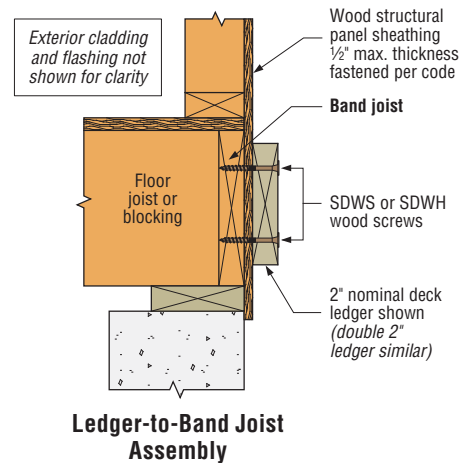

Strong-Drive® Structural Wood Screw

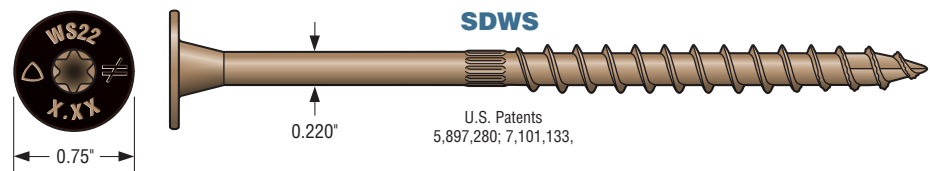

- 4CUT™ tip, serrated thread, and knurled shank reduce installation torque
- Identification on all screw heads
- Low-profile washer head provides excellent bearing area and a clean look

For stainless-steel ledger fastening, use the Strong-Drive SDS structural wood screw (page 21).

Code listed per IAPMO UES ER-192.

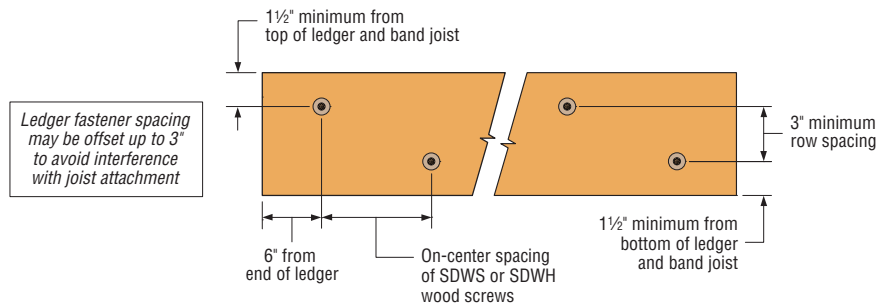

SDWS/SDWH Screw Spacing Detail

For more information on ledger attachment see *Fastening Systems* catalog C-FS and flier F-SDWSSDWH.

Lateral-Load Connection

For decks that are partially supported by an adjacent structure, the connection between the deck and that structure is vital. A bolted or screwed ledger-to-rim board connection is suitable to support gravity loads, however in some cases the building codes require a connection that is able to resist higher lateral loads. In these situations tension ties are typically called out to tie the joists of the deck directly to the joists of the structure.

The Simpson Strong-Tie® DTT2 Deck Tension Tie complies with IRC provisions for laterally tying the deck to the house. The DTT2 fastens easily to the joist using Simpson Strong-Tie® Strong Drive® screws (included).

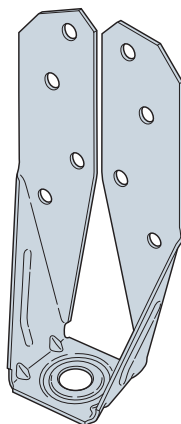

The DTT2Z Deck Tension Tie is a multi-purpose connector ideal for lateral load and deck-post connections. It features a ZMAX® coating for added corrosion resistance. For stainless steel model use the DTT2SS.

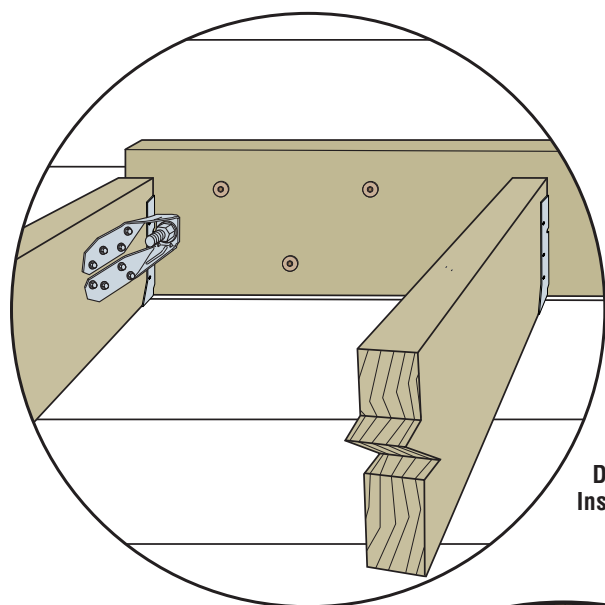

Deck to Ledger Installation Detail

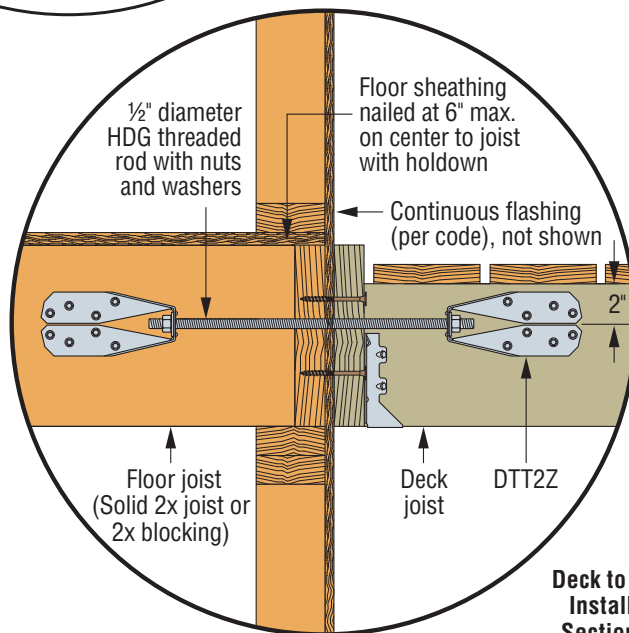

Deck to Ledger Installation Section View

For more information on common framing conditions not addressed by the 2009/2012 IRC detail, refer to Simpson Strong-Tie technical bulletin T-DECKLATLOAD.

Code Requirements

✓ The lateral load connection required by Section R502.2.2 shall be permitted to be in accordance with Figure R502.2.2.3. Hold-down tension devices shall be installed in not less than two locations per deck, and each device shall have an allowable stress design capacity of not less than 1500 pounds.

IRC 2009 Section R502.2.2.3

✓ The lateral load connection required by Section R507.1 shall be permitted to be in accordance with Figure R507.2.3. Where the lateral load connection is provided in accordance with Figure R507.2.3, hold-down tension devices shall be installed in not less than two locations per deck, and each device shall have an allowable stress design capacity of not less than 1500 pounds.

IRC 2012 Section R507.2.3

Selection of products based upon performance and/or suitability for a specific application should be made by a qualified professional. Simpson Strong-Tie recommends that deck designs be approved by the local building department before construction begins.



These products are available with a ZMAX® or hot-dip galvanized coating. Stainless-steel connectors are also available for higher exposure environments or applications using certain preservative-treated woods. See page 18 for more details.

Footings

Code Requirements

Footings

- ✓ The building codes include specific requirements regarding footing size that are dependent upon factors such as the dead and live loads the deck is designed to resist as well as soil conditions. Footing should be designed per

IRC 2009/2012, Section R403 or IBC 2009/2012, Chapter 18

Minimum Footing Depths By Code

(See the codes for actual footing size required.)

- ✓ Footings shall be at least 12" below the undisturbed ground surface.
IRC 2009/2012, Section R403.1.4
- ✓ The size of footings supporting piers and columns shall be based on the tributary load and allowable soil pressure in accordance with Table R401.4.1.
IRC 2009/2012 Section R403.1.1

Note: In order to achieve published load values, footings must provide sufficient concrete cover of the embedded portion of Simpson Strong-Tie® cast-in-place post and column bases. In some cases a footing larger than the minimum required by the building codes will be necessary to meet these requirements. See the Simpson Strong-Tie® *Wood Construction Connectors* catalog for more information.

In order for posts to properly resist various types of loads they must be supported by, and anchored to, concrete footings. Concrete patios and pre-cast concrete piers do not qualify as proper footings for deck construction.

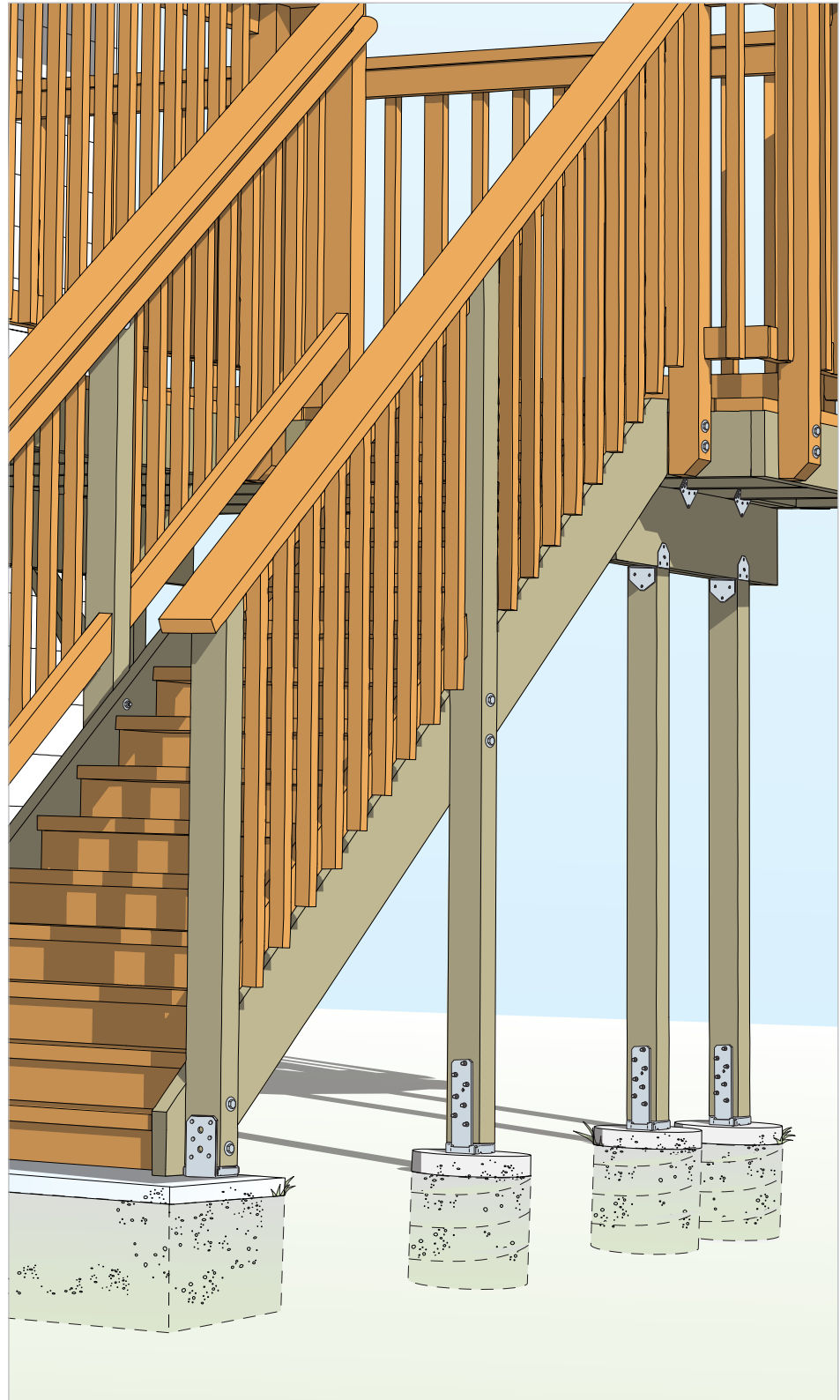

Post Bases (Hardened Concrete)

Posts must be correctly attached to a concrete footing in order to resist lateral and uplift loads. Preservative treated wood that is cut must be field treated or the post must be elevated off the concrete by 1".

Simpson Strong-Tie® Solutions

These products utilize anchors installed during the pour or after the concrete hardens.

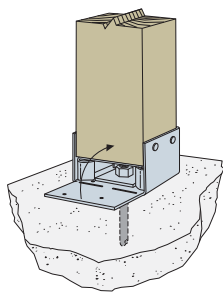

ABW Adjustable Post Base with Standoff
Available in ZMAX® coating.

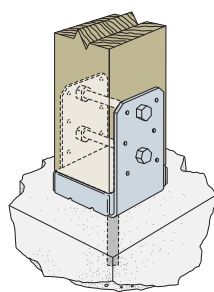

ABU Adjustable Post Base with Standoff
ZMAX coating or stainless steel recommended.

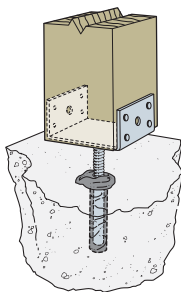

EPB44PHDG Elevated Post Base
Available with hot-dip galvanized coating

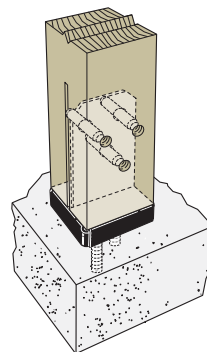

CPTZ Concealed Post Tie
Available in ZMAX coating.

Post-Installed Anchors

Installing a post base on hardened concrete requires the installation of a post-installed anchor to attach the base to the concrete. Simpson Strong-Tie offers a variety of mechanical anchors and anchoring adhesives that are code listed for structural applications.

Mechanical Anchors: Strong-Bolt® 2 Wedge Anchor

The Strong-Bolt® 2 wedge anchor is the next-generation solution for cracked and uncracked concrete. Available in stainless steel, it is code-listed by ICC-ES under the 2009 IBC requirements for post-installed anchors in cracked and uncracked concrete



Anchoring Adhesives

Anchoring adhesives are ideal when maximum strength is needed or when anchoring close to the edge of concrete or masonry. Simpson Strong-Tie® SET-XP® epoxy is a high-strength epoxy adhesive and AT-XP® is an acrylic formula ideal for fast cure and cold-weather applications. Both products are available in a variety of cartridge sizes, including convenient single-tube cartridges. Hot-dip galvanized or stainless-steel threaded rod recommended.



For more information on these products see the Simpson Strong-Tie® *Anchoring and Fastening Systems for Concrete and Masonry* catalog or visit www.strongtie.com/anchors.

Code Requirements

Load Resistance

- ✓ Columns shall be restrained to prevent lateral displacement at the bottom end. Wood columns shall not be less in nominal size than 4" x 4".

IRC 2009/2012, Section R407.3

- ✓ Column and post-end connections shall be fastened to resist lateral and net induced uplift forces.

IBC 2009/2012, Section 2304.9.7

Decay Resistance of Post

- ✓ Wood columns shall be approved wood of natural decay resistance or approved pressure-preservative-treated wood. Exception: Columns exposed to the weather when supported by concrete piers or metal pedestals projecting 1" above a concrete floor or 6" above exposed earth and the earth is covered by an approved impervious moisture barrier.

IRC 2009/2012 Section R317.1.4

IBC 2009/2012 Section 2304.11.2.7

Selection of products based upon performance and/or suitability for a specific application should be made by a qualified professional.

Simpson Strong-Tie recommends that deck designs be approved by the local building department before construction begins.

Post Bases (Wet Concrete)

Code Requirements

Load Resistance

- ✓ Columns shall be restrained to prevent lateral displacement at the bottom end. Wood columns shall not be less in nominal size than 4" x 4".

IRC 2009/2012, Section R407.3

- ✓ Column and post-end connections shall be fastened to resist lateral and net induced uplift forces.

IBC 2009/2012, Section 2304.9.7

Decay Resistance of Post

- ✓ Wood columns shall be approved wood of natural decay resistance or approved pressure-preservative-treated wood. Exception: Columns exposed to the weather when supported by concrete piers or metal pedestals projecting 1" above a concrete floor or 6" above exposed earth and the earth is covered by an approved impervious moisture barrier.

IRC 2009/2012 Section R317.1.4

IBC 2009/2012 Section 2304.11.2.7

Selection of products based upon performance and/or suitability for a specific application should be made by a qualified professional. Simpson Strong-Tie recommends that deck designs be approved by the local building department before construction begins.



These products are available with a ZMAX® or hot-dip galvanized coating. Stainless-steel connectors are also available for higher exposure environments or applications using certain preservative-treated woods. See page 18 for more details.

Simpson Strong-Tie® Solutions

Cast-in-Place

These products are cast into the concrete at the time of the pour.

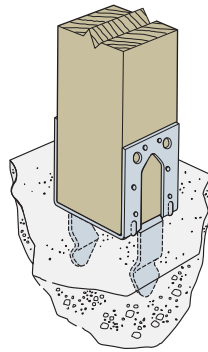

PB Post Base:

For use with decay resistant or preservative-treated wood. ZMAX® or hot-dip galvanized coating recommended.

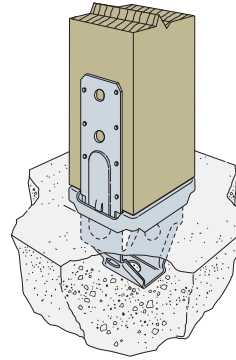

PBS Post Base with Standoff:

Features a 1" standoff. ZMAX or hot-dip galvanized coating recommended.

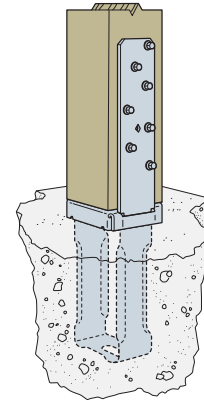

CBSQ Column Base:

Installs with Strong-Drive® SDS wood screws and features a 1" standoff. Hot-dip galvanized coating recommended.

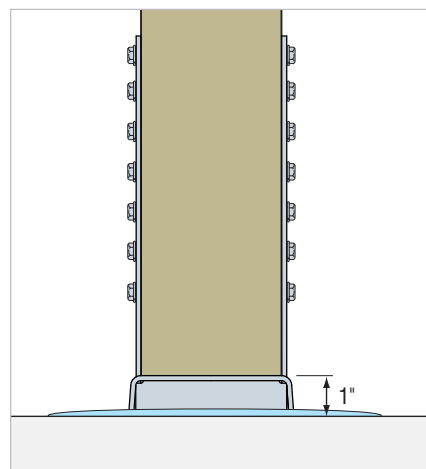

A 1" standoff at the base of the post is required when building with wood that is not preservative treated or decay resistant. The standoff plate raises the post end off the concrete, keeping it drier and reducing the chances of decay. For best long-term results, Simpson Strong-Tie recommends that a base with a standoff be used in exterior/wet applications.

Beam-to-Post Connections

At the point where a beam meets a post, it must be properly connected to the post in order to resist gravity, lateral and uplift loads. This pertains to solid sawn beams or those comprised of multiple members, whether they rest on top or are fastened to the side of the post.

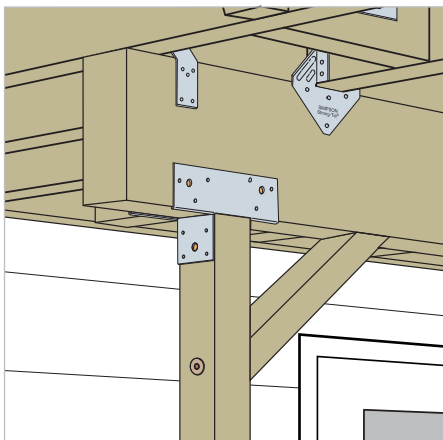
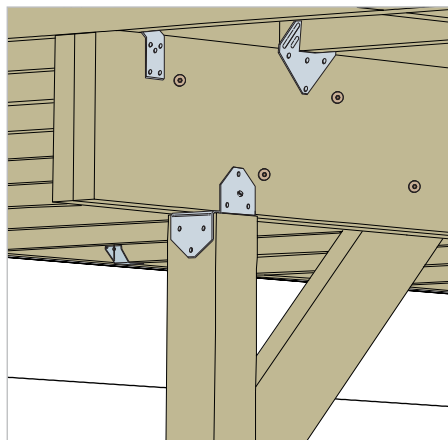

Code Requirements

- ✓ Where posts and beam or girder construction is used to support floor framing, positive connections shall be provided to ensure against uplift and lateral displacement.

*IRC 2009/2012, Section R502.9
IBC 2009/2012, Section 2304.9.7*

Selection of products based upon performance and/or suitability for a specific application should be made by a qualified professional. Simpson Strong-Tie recommends that deck designs be approved by the local building department before construction begins.

Simpson Strong-Tie® Solutions

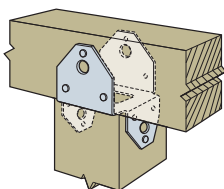

BC Post Cap: For single-member solid sawn beams. ZMAX® coating or stainless steel recommended.

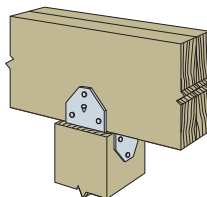

BCS Post Cap: Connects double 2x's to a 4x post or triple 2x's to a 6x post. ZMAX coating or stainless steel recommended.

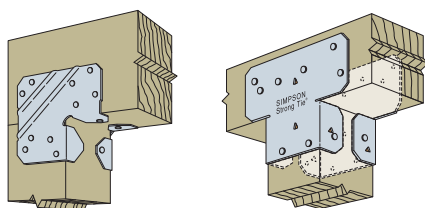

LCE/AC Retrofit Post Caps: Two-piece cap may be installed before or after lumber is in place when the sides of the post and beam are flush. ZMAX coating or stainless steel recommended.

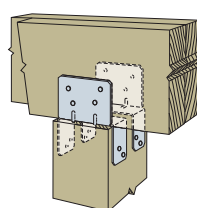

LPC Post Cap: Two-piece cap adjusts for beams smaller than post width. Features a ZMAX coating.

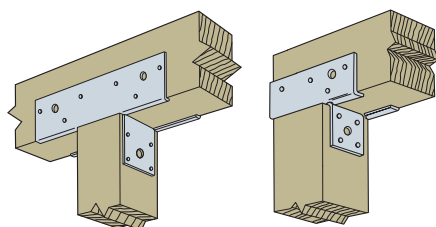

PC/EPC Post Caps: Connects beams at the top of the post. ZMAX coating recommended.

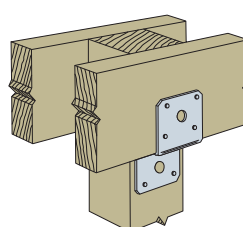

DJT14: Connects beams at the side of the post. ZMAX coating or stainless steel recommended.



These products are available with a ZMAX® or hot-dip galvanized coating. Stainless-steel connectors are also available for higher exposure environments or applications using certain preservative-treated woods. See page 18 for more details.

Joists Terminating into Beam/Ledger

Code Requirements

Bearing

- ✓ The ends of each joist, beam or girder shall have at least 1½" of bearing on wood or metal except where supported on a 1"x4" ribbon strip nailed to adjacent studs.

*IRC 2009/2012, Section R502.6
IBC 2009/2012, Section 2308.8.1*

- ✓ Joists framing into the side of a wood beam shall be supported by approved framing anchors.

*IRC 2009/2012, Section R502.6.2
IBC 2009/2012, Section 2308.8.2*

Cantilevered Applications

- ✓ Decks with cantilevered framing members, connections to exterior walls or other framing members shall be designed and constructed to resist uplift resulting from the full live load acting on the cantilevered portion of the deck.

*IRC 2009, Section R502.2.2
IRC 2012, Section R507.1
IBC 2009/2012, Section 1604.8.3*

Selection of products based upon performance and/or suitability for a specific application should be made by a qualified professional. Simpson Strong-Tie recommends that deck designs be approved by the local building department before construction begins.

When joists terminate into a beam or ledger, a connection is required to provide bearing. In cantilever applications the connection must also resist uplift.

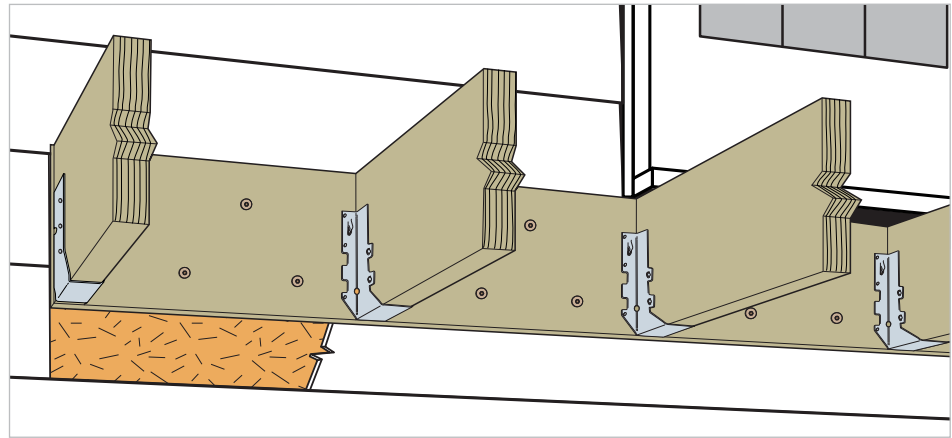

Ledger may not be installed over siding or stucco. It must be fastened directly to the rim joist or sheathing.

Simpson Strong-Tie® Solutions

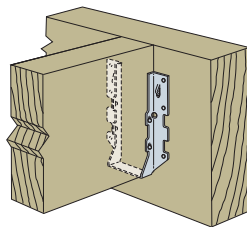

LUS Joist Hanger: Provides bearing and uplift resistance, features double-shear nailing for added strength. ZMAX® coating or stainless steel recommended.

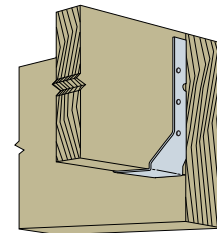

LUC Concealed Flange Joist Hanger: Provides bearing and uplift resistance, concealed flanges for cleaner look and for end conditions. ZMAX coating or stainless steel recommended.

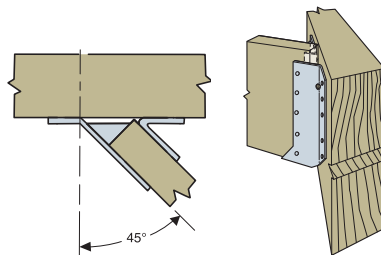

SUR/SUL Skewed Joist Hanger: 45° skewed hanger (available in skewed right and left versions), provides bearing and uplift resistance. ZMAX coating or stainless steel recommended.

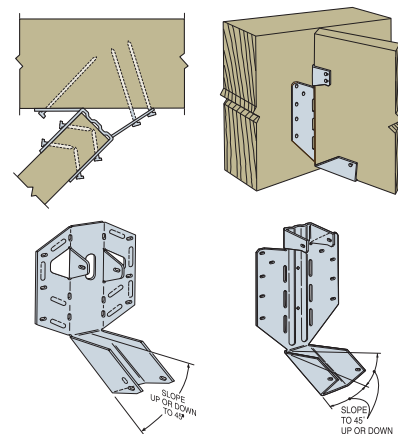

LSU26/LSSU210 Field Skewable Joist Hanger: Field skewable right or left up to 45°, provides bearing and uplift resistance. Also field slopeable up or down to 45°. Available with a ZMAX coating.

Joists Bearing on a Beam

At the point where the joist bears on top of a beam, there must be a connection to resist lateral and uplift forces. Blocking or framing is also required to prevent overturning of the joists.

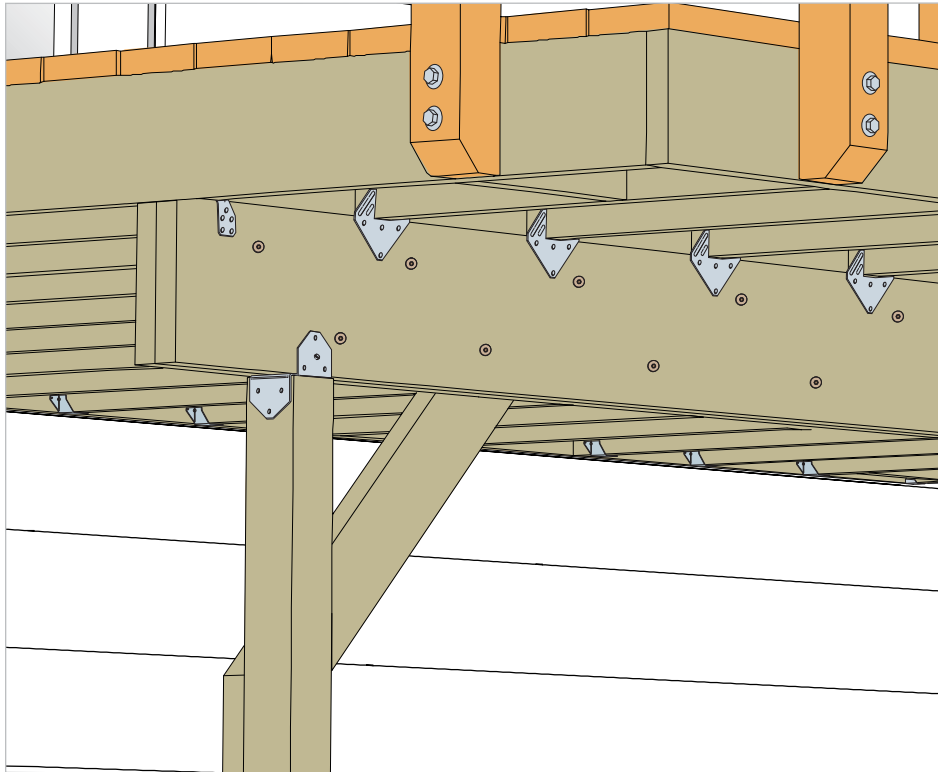

Code Requirements

- ✓ Where posts and beam or girder construction is used to support floor framing, positive connections shall be provided to ensure against uplift and lateral displacement.

*IRC 2009/2012, Section R502.9
IBC 2009/2012, Section 2304.9.7*

- ✓ Joists must be supported laterally at the ends by solid blocking or attachment to a full depth header, band or rim joist. Lateral restraint must be provided at each support.

*IRC 2009/2012 Section R502.7
IBC 2009/2012 Section 2308.8.2*

Selection of products based upon performance and/or suitability for a specific application should be made by a qualified professional. Simpson Strong-Tie recommends that deck designs be approved by the local building department before construction begins.

Simpson Strong-Tie® Solutions

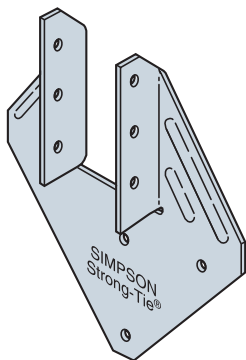

H1 Hurricane Tie: Holds joist on both sides. ZMAX® coating recommended.

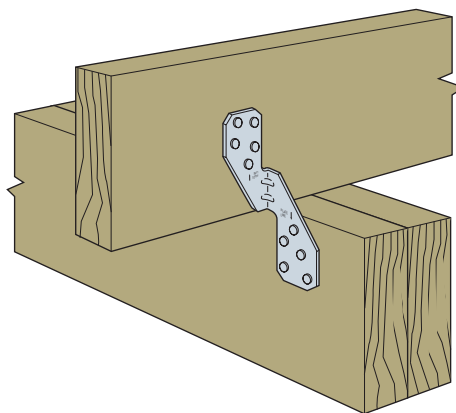

H2.5A Hurricane Tie: Suitable for single-sided applications. ZMAX coating or stainless steel recommended.

Simpson Strong-Tie offers a full range of hurricane ties for all types of applications and load requirements. See the Simpson Strong-Tie® *Wood Construction Connectors* catalog for more information.

Railing Post-to-Deck Framing

Code Requirements

When required

- ✓ Guards shall be located along many surfaces more than 30" above the floor or grade below including porches, balconies, raised floor areas, stairways, landings and open-sided walking surfaces.

IRC 2009, Section R312.1
IRC 2012, Section R312.1.1
IBC 2009, Section 1013.1
IBC 2012, Section 1013.2

Height

- ✓ Guards shall be a minimum of 36" tall (IRC) or up to 42" tall for certain occupancies (IBC).

IRC 2009, Section R312.2
IRC 2012, Section R312.1.2
IBC 2009, Section 1013.2
IBC 2012, Section 1013.3

Load Resistance

- ✓ Handrail assemblies and guards shall be able to resist a single concentrated load of 200 pounds, applied in any direction at any point along the top.

IRC 2009/2012, Table R301.5
IBC 2009, Section 1607.7.1
IBC 2012, Section 1607.8.1
(1 and 2 family dwellings)

Selection of products based upon performance and/or suitability for a specific application should be made by a qualified professional. Simpson Strong-Tie recommends that deck designs be approved by the local building department before construction begins.



These products are available with a ZMAX® or hot-dip galvanized coating. Stainless-steel connectors are also available for higher exposure environments or applications using certain preservative-treated woods. See page 18 for more details.

The railing post connection is a crucial connection pertaining to safety, and it is often inadequately constructed. In order to provide the required load resistance at the guardrail, the post must not only be fastened to the rim joist, but also tied back into the joist framing. Machine bolts through the post and rim joist alone do not typically meet the performance requirements of the code. The details below have been shown through testing to resist the forces called out by the codes for a maximum guardrail height of 36" above the deck surface.

Simpson Strong-Tie® Solutions

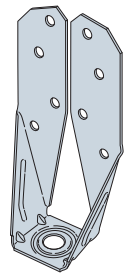

DTT2 Deck Tension Tie: ZMAX® coating or stainless steel recommended.

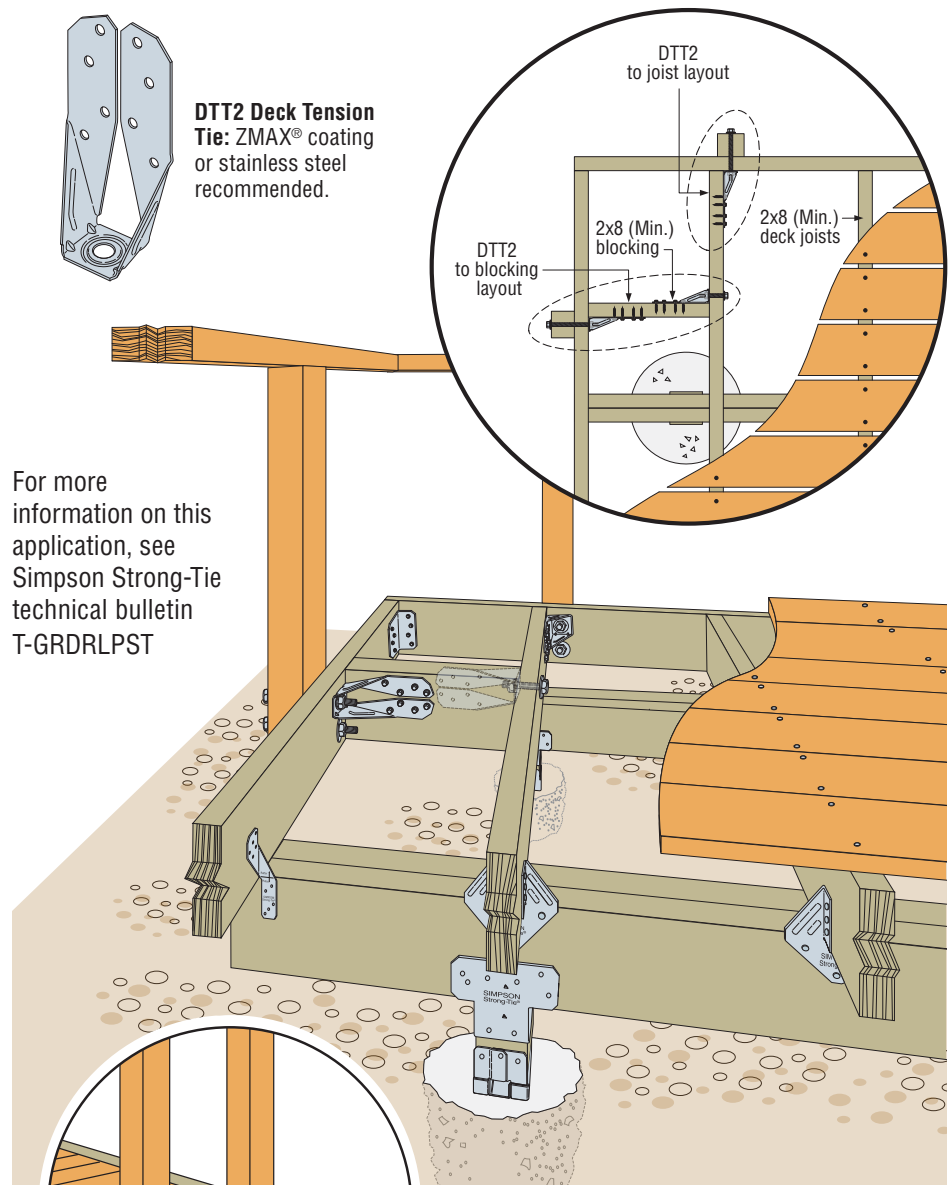

For more information on this application, see Simpson Strong-Tie technical bulletin T-GRDRLPST

For a 42" tall guardrail see engineering letter L-GRDRLPST42 on www.strongtie.com.

For more information on connecting posts inside the rim joist, see Simpson Strong-Tie technical bulletin T-GRDRLPST.

Stair Stringers & Treads

Stair stringers must be properly connected to the deck, and treads properly connected to the stringers, in order to resist loads. In addition, code requirements regarding openings between stair treads and stair railing must also be met.



Code Requirements

Stair Stringer to Rim Joist

- ✓ Staircases must be able to resist 40 pounds per square foot of tread area.

*IRC 2009/2012, Table R301.5
IBC 2009/2012, Table 1607.1
(1 and 2 family dwellings)*

Stair Tread to Stringer

- ✓ Individual stair treads shall be able to resist a 300 lb. concentrated load acting over an area of 4 square inches.

*IRC 2009/2012, Table R301.5
IBC 2009/2012, Table 1607.1
(1 and 2 family dwellings)*

Railing to Stringer Opening:

- ✓ Guard openings shall not allow passage of a 4" sphere. Exceptions: The triangular opening formed by the riser, tread and bottom rail of a guard at the open side of a stairway shall be of such a size that a sphere 6" in diameter cannot pass through.

*IRC 2009 Section R312.3
IRC 2012 Section R312.1.3
IBC 2009 Section 1013.3
IBC 2012 Section 1013.4*

Additional IRC Exception: Openings for required guards on the sides of stair treads shall not allow a sphere 4 $\frac{3}{8}$ " to pass through.

*IRC 2009 Section R312.3
IRC 2012 Section R312.1.3*

Selection of products based upon performance and/or suitability for a specific application should be made by a qualified professional.

Simpson Strong-Tie recommends that deck designs be approved by the local building department before construction begins.

Simpson Strong-Tie® Solutions

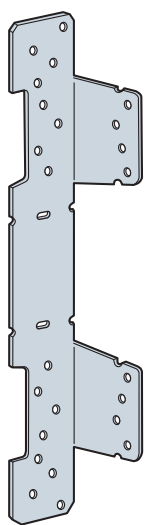

LSC

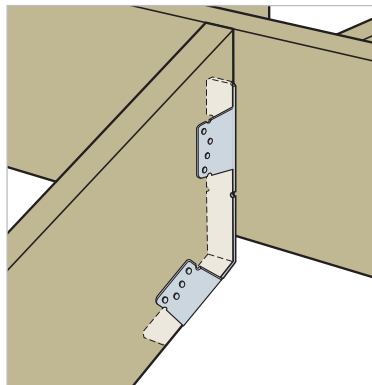

LSC Adjustable Stair Stringer Connector: Field slopable to almost any angle, the LSC is ideal for attaching the staircase stringer to the deck. Suitable for solid and notched stringers. ZMAX® coating or stainless steel coating recommended

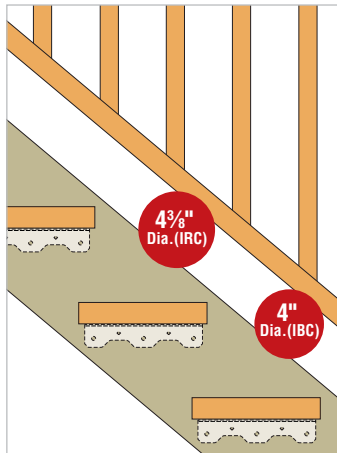

Codes require that a 4 $\frac{3}{8}$ " (IRC) or 4" (IBC) sphere must not be able to pass between any guard opening at stairs. Using the TA makes it easier to meet these requirements.

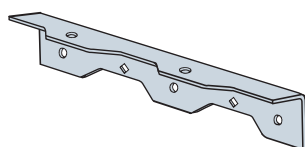

TA Tread Angle: Provides a positive connection, eliminating the need to notch the stringer. A full-width stringer is stronger and makes it easier to meet maximum guardrail opening requirements of the codes. ZMAX coating or stainless steel recommended.

Selecting Connectors & Fasteners

Corrosion Issues

When selecting hardware or fasteners for deck construction it is important to use connectors with a level of corrosion resistance appropriate to the application.

Outdoor environments are generally more corrosive to steel because connectors are exposed to the elements. If building a deck in an area especially prone to moisture, such as homes along the coast or near bodies of water, the risk of corrosion is much higher. In addition, the chemicals used in some preservative-treated woods have been found to increase the corrosion of connectors and fasteners. Other corrosion risk factors include exposure to fire retardants, fumes, fertilizers, soil, industrial zones, acid rain, and other corrosive elements.

Depending on the deck materials and environmental conditions, Simpson Strong-Tie® ZMAX® coated (G185) and hot-dip galvanized (HDG) connectors and fasteners may provide adequate corrosion resistance. If you choose to use ZMAX or HDG on your deck project, you should periodically inspect your connectors and fasteners or have a professional inspection performed. Regular maintenance including water-proofing of the wood used to construct your deck is also a good practice. When using ZMAX/HDG connectors, you must use fasteners galvanized per ASTM A153, SDS screws with a double-barrier coating, or SD screws with a mechanically-galvanized coating.

For higher exposure applications, stainless-steel connectors and fasteners offer the best defense against corrosion. Simpson Strong-Tie offers a variety of connectors and fasteners for deck construction in stainless steel. Remember when using stainless-steel connectors, you must also use stainless-steel fasteners.

For more information on corrosion and selecting the appropriate finish for your application visit www.strongtie.com/info.

Use the chart below, which was created based on Simpson Strong-Tie testing and experience, to select the connector finish or material suitable for various types of preservative-treated wood.



Environment/Treatment Classification Chart

Environment	Material to be Fastened							ACZA	Other or Uncertain
	Untreated Wood or Other Material	Preservative-Treated Wood							
		SBX/DOT & Zinc Borate	MCQ/MCA	ACQ-C, ACQ-D (Carbonate), CA-B, CA-C/μCA-C					
			Without Ammonia	With Ammonia	Higher Chemical Content				
Interior – Dry	Low	Low	Low	Med ³	Med	High	High	High	
Exterior – Dry	Low	N/A	Med	Med	High	High	High	High	
Exterior – Wet	Med	N/A	Med	Med	High	High	High	High	
Higher Exposure	High	N/A	High	High	High	High	High	High	
Uncertain	High	High	High	High	High	High	High	High	

- Higher chemical content refers to wood for ground contact with actual retention levels greater than 0.40 pcf for ACQ, 0.34 pcf for MCQ, 0.21 pcf for CA-B, 0.15 pcf for CA-C and MCA, or 0.14 pcf for μCA-C. In these cases, stainless-steel products are recommended. Verify actual retention levels with the wood treater.
- Borate treated woods are not appropriate for outdoor use.
- Where noted in the table, applications where the wood is dry (*moisture content less than 19%*) when installed and will remain dry in-service may use a minimum classification coating recommendation of “Low” for connectors.
- Some treated wood may have excess surface chemicals making it potentially more corrosive. If uncertain, use types 304/305/316 stainless steel products.
- Test results indicate that ZMAX®, hot-dip galvanized, mechanically galvanized (*class 55 and 65*) and double-barrier coatings (*SDS screws*) will perform adequately, subject to regular maintenance and periodic inspection. However, the test protocol followed was a modified version of the nationally recognized test method AWPA E12-94. This test method is an accelerated test, so data over an extended period of time is not available. Also noteworthy is that tests run in a laboratory may not correlate to service conditions. If uncertain, use stainless steel.
- Type 316 stainless-steel products are the minimum recommendation for ocean-salt air and other chloride environments.
- Ammonia is typically used as a chemical carrier for difficult to treat wood species, such as, but not exclusive to, Douglas Fir and Hem Fir, which are usually found in the western United States. Amine carriers are used in some of the eastern species, such as Southern Yellow Pine. If uncertain, verify chemical with wood treater.
- Exterior Dry applications only apply to connectors. For anchors, use Exterior Wet for any exterior application.
- Mechanically galvanized Titen HD® anchors (*medium classification*) are only recommended for temporary exterior applications.

Coatings Available

Not all products are available in all finishes. Contact Simpson for product availability, ordering information and lead times.

Finish/Material	Description	Level of Corrosion Resistance
Gray Paint	Water-based paint intended to protect the product while it is warehoused and in transit to the jobsite.	Low
Powder Coating	Baked on paint finish that is more durable than our standard paint and produces a better looking finished product.	Low
Standard G90 Zinc Coating	Zinc galvanized coating containing 0.90 oz. of zinc per square foot of surface area (<i>total both sides</i>).	Low
 ZMAX G185	Galvanized (G185) 1.85 oz. of zinc per square foot of surface area (<i>hot-dip galvanized per ASTM A653 total both sides</i>). These products require hot-dip galvanized fasteners (<i>fasteners which meet the specifications of ASTM A153</i>).	Medium
 HOT-DIP GALVANIZED	Products are hot-dip galvanized after fabrication (14 ga. and thicker). The coating weight increases with material thickness. The minimum specified coating weight is 2.0 oz./ft ² (<i>per ASTM A123 total both sides</i>). These products require hot-dip galvanized fasteners (<i>fasteners which meet the specifications of ASTM A153</i>).	Medium
Type 410 Stainless Steel with Protective Top Coat	Carbon martensitic grade of stainless steel which is inherently magnetic, with an added protective top coat. This material can be used in mild atmospheres and many mild chemical environments.	Medium
Mechanically-Galvanized Coating, Class 55 (SD screws)	Simpson Strong-Tie Strong-Drive® SD structural-connector screws are manufactured with a mechanically-applied zinc coating in accordance with ASTM B695, Class 55 with a supplemental overcoat. These fasteners are compatible with painted and zinc-coated (G90 and ZMAX) connectors.	Medium
Double-Barrier Coating (SDS Screws)	Simpson Strong-Tie Strong-Drive SDS screws are manufactured with two different finishes that together provide a level of corrosion protection that equals that provided by the previous HDG coating.	Medium
 316 STAINLESS STEEL	Connectors are manufactured from Type 316L stainless steel, and provide greater durability against corrosion. Stainless-steel fasteners are required with stainless-steel products, and are available from Simpson Strong-Tie.	High

Stainless-Steel Connectors



The Science Behind Stainless Steel

Each Simpson Strong-Tie® stainless-steel connector is made with type 316L stainless steel. Because it contains an additional level of nickel chromium, type 316L stainless steel develops a thin coat of chromium oxide on the surface of the metal that insulates the connector from corrosive attack. Molybdenum is also added, which helps increase corrosion resistance in chloride-type areas, such as salt water environments. Type 316L has shown no visible sign of surface red rust after 1,000 hours of an ASTM B117 salt spray test. For more information about corrosion, visit www.strongtie.com/corrosion.

Common Corrosive Factors That Can Negatively Affect Structural Connections

- Ocean salt air
- Water
- Preservative-treated wood
- Fire retardant-treated wood
- Salt used to de-ice or melt snow
- Pool or hot tub chemicals
- Fertilizers
- Soil
- Industrial zones
- Concrete

Always Use Stainless-Steel Fasteners with Stainless-Steel Connectors



Model	Description
Joist Hangers Face Mount	
LUC26SS	For 2x6, 2x8 joist
LUC210SS	For 2x10, 2x12 joist
LUS26SS	For 2x6, 2x8 joist
LUS28SS	For 2x8, 2x10 joist
LUS210SS	For 2x10, 2x12, 2x14 joist
LUS26-2SS	For Double 2x6, 2x8 joist
LUS28-2SS	For Double 2x8, 2x10 joist
LUS210-2SS	For Double 2x10, 2x12 joist
SUL26SS	Skewed 45° left for 2x6, 2x8 joist
SUR26SS	Skewed 45° right for 2x6, 2x8 joist
SUL210SS	Skewed 45° left for 2x10, 2x12 joist
SUR210SS	Skewed 45° right for 2x10, 2x12 joist
Post Caps	
AC4SS	For 4x beam, 4x post
ACE4SS	For 4x beam, 4x post
AC6SS	For 6x beam, 6x post
ACE6SS	For 6x beam, 6x post
LCE4SS	For 4x or 6x post
Caps	
BC4SS	For 4x beam, 4x post
BC6SS	For 6x beam, 6x post
BCS2-2/4SS	For Double 2x beam to 4x post
BCS2-3/6SS	For Triple 2x beam to 6x post
BC40SS	For 4x beam
Post/Column Bases	
ABU44SS	For 4x4 post
ABU46SS	For 4x6 post
ABU66SS	For 6x6 post
ABU88SS	For 8x8 post
CB44SS	For 4x4 post
CB66SS	For 6x6 post
CBSQ44SS	For 4x4 column
CBSQ46SS	For 4x6 column
CBSQ66SS	For 6x6 column
Hurricane Ties	
H2ASS	For joist to beam
H2.5ASS	For joist to beam
H3SS	For joist to beam
H4SS	For joist to beam
H5SS	For joist to beam
H8SS	For joist to beam
H10ASS	For joist to beam
HPTSS	For joist to beam
Framing Angles	
A34SS	Multi-purpose angle
A35SS	Multi-purpose angle
LS50SS	Skewable angle
ML24SS	Multi-purpose angle
ML26SS	Multi-purpose angle
TA9SS	Staircase angle
TA10SS	Staircase angle
Straps	
LTS12SS	Light twist strap
LTS18SS	Light twist strap
MTS12SS	Medium twist strap
MSTA12SS	Straight strap
MSTA18SS	Straight strap
MSTA24SS	Straight strap
MSTA36SS	Straight strap
Miscellaneous	
DJT14SS	For side-loaded 2x beams
DTT2SS	Deck tension tie
LSCSS	Stair stringer

Correct Fasteners for Use with Simpson Strong-Tie® Connectors



Fastener Types and Sizes Specified for Simpson Strong-Tie® Connectors

Many Simpson Strong-Tie connectors have been designed and tested for use with specific types and sizes of fasteners. The specified quantity, type and size of fastener must be installed in the correct holes on the connector to achieve published loads.

Other factors such as fastener material and finish are also important. Incorrect fastener selection or installation can compromise connector performance and could lead to failure.

Simpson Strong-Tie does not offer all of these fasteners, see www.strongtie.com/fastenerfinder or *Wood Construction Connectors* catalog for more information.

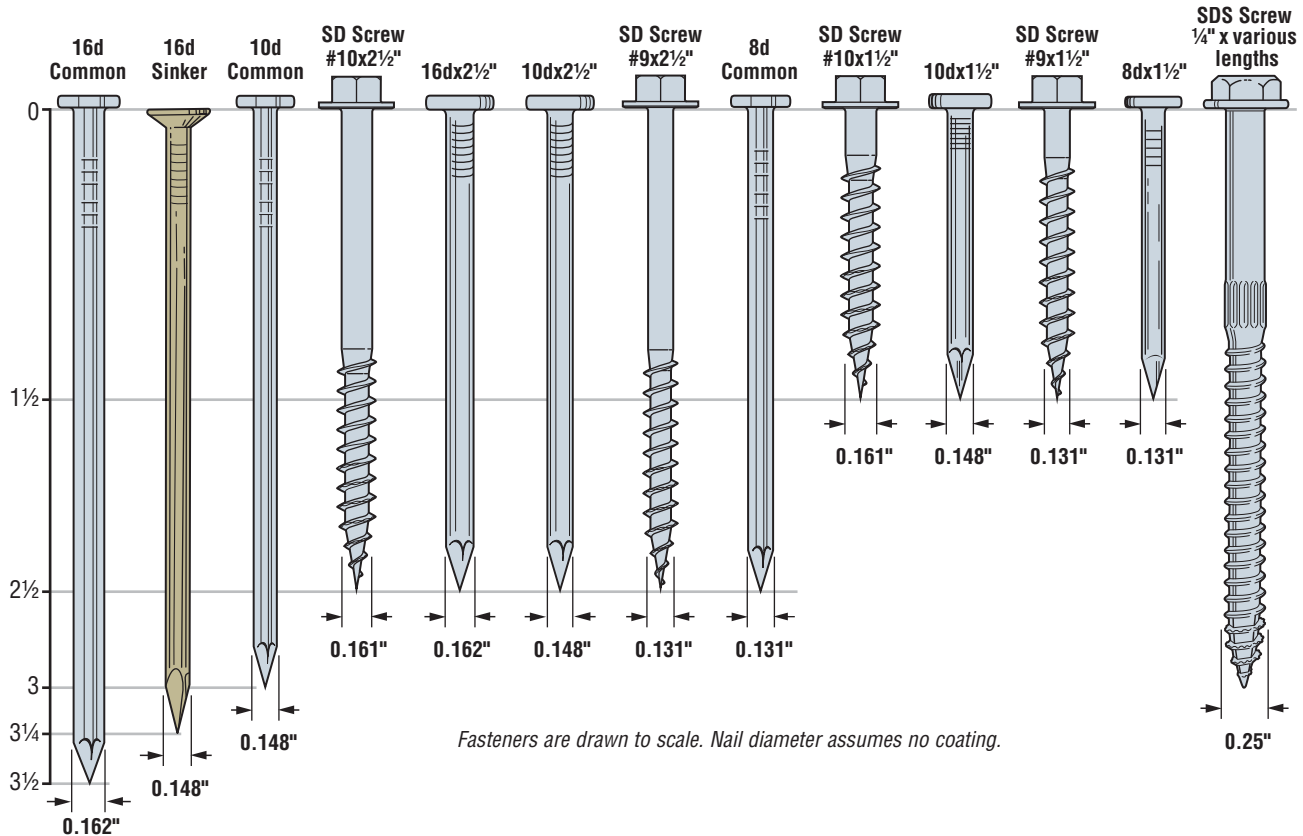

Incorrect Applications

SHORT NAILS Do not use short (1½") nails for double shear nailing.

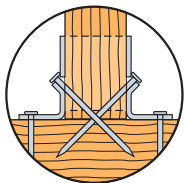

Double shear nailing should use full length common nails

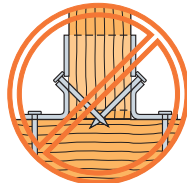

Shorter nails may not be used as double shear nails



FRAMING NAIL-GUNS

Collated framing-nailer fasteners can only be used if:

1. Correct diameter and length
2. Correct material or finish is installed
3. Correct quantity is installed
4. Driven with a hole-locating tool (*finds the hole*) or by hand

NOTE:

- Nails with .131 diameter may not be used to replace 10d common or 16d sinker nails
- Do not overdrive
- Drive only through punched holes

See technical bulletin T-PNEUMATIC for more information.

Pneumatic nails must meet ASTM A153 or equivalent specification for ZMAX® or hot dipped galvanized applications. Most framing nails are only zinc plated and do not meet this outdoor preservative treated wood requirement.



The Simpson Strong-Tie Strong-Drive® SD structural-connector screw is the only screw approved for use with our connectors.

Consult the current Simpson Strong-Tie *Wood Construction Connectors* catalog for complete fastener and fastening requirements.

Structural Wood Fastening

Structural Wood-to-Wood Connections

Simpson Strong-Tie® Strong-Drive® structural wood screws make high-strength wood-to-wood connections easier and stronger. Designed for both ease of installation and superior strength, these versatile screws are a time-saving alternative to multiple smaller fasteners or larger screws or bolts that require pre-drilling.



Strong-Drive® SDWS and SDWH Structural Wood Screw

The Simpson Strong-Tie Strong-Drive SDWS and SDWH wood screws are designed to provide an easy-to-install, high-strength alternative to through-bolting and traditional lag screws. These structural wood screws are ideal for the contractor and do-it-yourselfer alike.

Features:

- Bold thread design that provides superior holding power
- Double-barrier coating
- Patented 4CUT™ tip that ensure fast starts, reduces installation torque and eliminates the need for pre-drilling in most applications
- Under-head nibs that offer greater installer control when seating the head
- Large washer head provides maximum bearing area

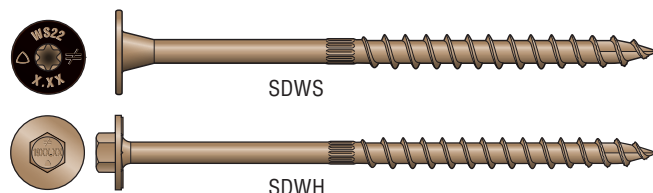

Codes/Standards: IAPMO UES ER-192

Strong-Drive® SDS Structural Wood Screw

The Simpson Strong-Tie Strong-Drive SDS screw is a ¼" diameter high-strength structural wood screw ideal for various connector installations as well as wood-to-wood applications.

Features:

- Available with a double-barrier coating or type 316 stainless steel
- Patented 4-CUT™ point (coated version) and type-17 point (stainless version) enable easy driving with no pre-drilling and minimal splitting
- Double-barrier coating provides corrosion resistance equivalent to hot-dip galvanization
- Head is stamped with the Simpson Strong-Tie® "≠" sign and fastener length for easy identification after installation

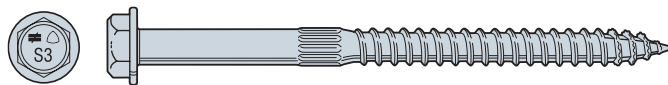

Codes/Standards: ICC-ES ESR-2236

Strong-Drive® Stainless-Steel Heavy-Duty Wood Screw

The Simpson Strong-Tie Strong-Drive stainless steel heavy-duty wood screws are designed for lag screw replacement. These load-rated ¼" and ⅜" diameter hex-head fasteners require no pre-drilling, making them easier to install than typical lag screws.

Features:

- Shear load values exceed that of a ½" lag screw
- Type 316 stainless steel for superior corrosion resistance
- Type-17 point provides fast starts and eliminates predrilling in most applications
- 4-corner box thread design significantly reduces driving torque compared to lag screws
- Code-equivalent fastening for deck ledger-to-band joist connections

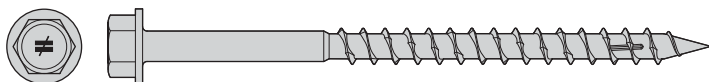

Corrosion-Resistant Fasteners for Decking



Simpson Strong-Tie offers a variety of premium solutions for fastening wood, PVC or composite decking. Our fasteners are designed specifically to perform in their target decking material and many of our fasteners are available in colors to provide a fastening solution that blends with the deck surface.

Stainless-Steel Screws

Bugle-Head Wood Decking Screw

For all types of wood decking including cedar, redwood and preservative-treated woods (*non-hardwood*)

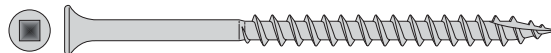

Hardwood Decking Screw

For the hardest wood products



Trim-Head Decking Screw

For wood decking and some composite decking materials

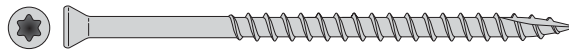

Dexxter

For composite decking

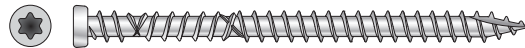

Exterior Grade Screws

DSV Decking Screw

For preservative-treated wood



Trim-Head Decking Screw

For wood decking and some composite decking materials



Dexxter

For composite decking

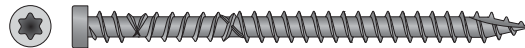

For more information on fasteners, please visit www.strongtie.com/fastenerfinder.

Corrosion-Resistant Fasteners for Decking

Stainless-Steel Nails

Hand-Drive Decking and Siding Nails



15° Wire Coil, Full Round Checked Head, Ring Shank. Types 304 and 316 Stainless Steel



20–22° Plastic Strip, Full Round Checked Head, Ring Shank Types 304 and 316 Stainless Steel

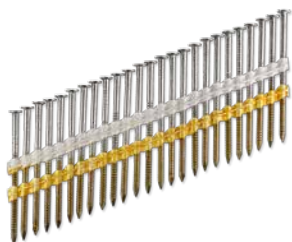

20–22° Plastic Strip, Full Round Smooth Head, Screw Shank Types 304 and 316 Stainless Steel

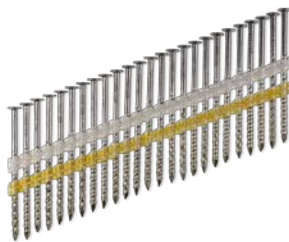

20–22° Plastic Strip, Checkered, Casing Head, Ring Shank Type 304 Stainless Steel



28° Wire Weld, Clipped Smooth Head, Ring Shank Type 304 Stainless Steel



31–34° Plastic Strip, Full Round Checked Head, Ring Shank Types 304 and 316 Stainless Steel



31–34° Paper Tape, Clipped Smooth Head, Ring Shank Types 304 and 316 Stainless Steel



For more information on fasteners, please visit www.strongtie.com/fastenerfinder.

Quik Drive® Auto-Feed Screw Driving Systems for Decks



Shown with Deck Clip QDDECKCLIP-RC

Quik Drive auto-feed screw driving systems are ideal for fastening decking because they combine the efficiency of stand-up driving with the holding power of screws, providing the best long-term results.

PROSDD/CCS+ Combo System



Applications: Decks/docks, subfloor, sheathing, wall plates, stair treads, fiber-cement siding, drywall

- Expanded depth settings for high-density materials
- Reversible and replaceable non-skid teeth
- Uniform toenailing and countersink on slick surfaces
- Two screw driving attachments for added versatility





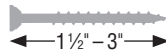

PRO300S System

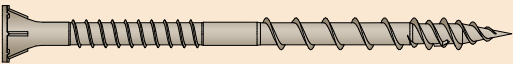

Applications: Decks/docks, subfloor, wall plates, stair treads

- Expanded depth settings for high-density materials
- Reversible and replaceable non-skid teeth
- Includes a decking nose clip to position decking screws quickly and precisely every time
- Uniform toenailing and countersink on slick surfaces
- Sure-grip guide tube increases stability for a broad range of screws

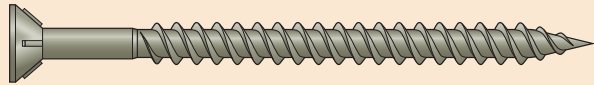

<p>DSV Decking Screw Rimmed flat head with nibs Quik Guard® coating</p> 
<p>WSNTLG Wood Screw Twin thread Class 55 galvanized coating</p> 
<p>WSNTLQ Wood Screw Twin thread Quik Guard® coating</p> 
<p>DTHQ Decking Screw Trim head Quik Guard® coating</p> 

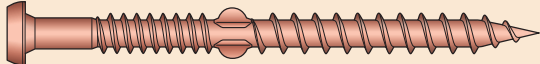
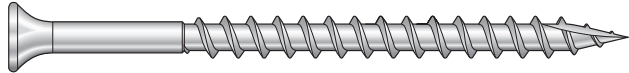
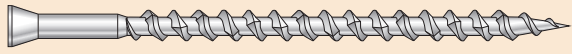
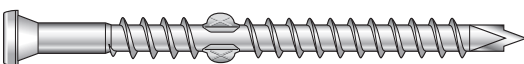
<p>Composi-Lok™ (DCL) Composite-Decking Screw 4 colors available Type 305 stainless steel</p> 
<p>SS3DSC Wood Screw #10 bugle head Types 305 and 316 stainless steel</p> 
<p>SSDTH Wood Screw #8 trim head Type 305 stainless steel</p> 
<p>DHPD Hardwood-Decking Screw Paddle-style drill point Type 305 stainless steel</p> 

Color-Match Fasteners for Composite and PVC Decking

Decking Meets its Match

Simpson Strong-Tie® color matched hand drive and collated fasteners are available in a color palette specifically formulated to match a wide range of the most popular decking systems, and are designed to blend into the decking material.

Trim-Head PVC Decking: Azek, Cevn, Gossen, Timber Tech, Trex, Veka Deck

Composite or Encapsulated Decking: ChoiceDek, Evergrain, Fiberon, Moisture Shield, Timber Tech, Trex

For more information on Simpson Strong-Tie Color-Match Fasteners please see flier F-FSTCLRMTCH12.

AZEK, Cevn, ChoiceDek, Evergrain, Fiberon, Gossen, MoistureShield, TimberTech and VekaDeck are trademarks or registered trademarks of their respective holders. Trex and Trex Escapes are registered trademarks of Trex Company, Inc.



Composite or Encapsulated-Composite Decking

Dexxter™ Screw

- Trim pan head to reduce mushrooming and conceal installation
- Available in colors to match popular composite deck boards
- Available with Quik Guard® coating and stainless steel

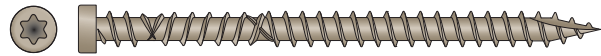

Composi-lok™ Screws

- Cap head to reduce mushrooming and conceal installation
- Available in hand-drive or collated for the Quik Drive® auto-feed system
- Available with Quik Guard® coating and stainless steel

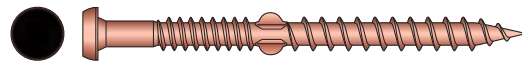

PVC Decking Fasteners

Trim-Head Decking Screw, Stainless Steel, Square Drive

- Trim-style head reduces appearance of installed fasteners on deck surface
- Available in hand-drive or collated for the Quik Drive® auto-feed system
- Available in colors formulated to match Azek®, Veka® and other PVC decking systems

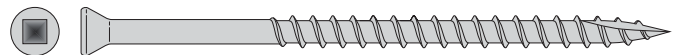

Trim-Head Decking Screw, Stainless Steel, 6-Lobe Drive

- Trim-style head reduces appearance of installed fasteners on deck surface
- Available in colors formulated to match Trex® Escapes® and other popular PVC deck systems

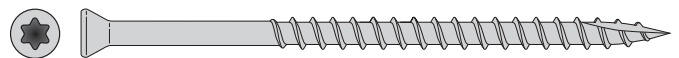

Hardwood Decking Fasteners

DHPD Hardwood Decking Screw, Stainless Steel

- Compact head ensures low-profile installation and reduced visibility
- Paddle-style drill point virtually eliminates splitting without predrilling
- Available in hand-drive or collated for the Quik Drive® auto-feed system



Hardwood Decking Screw, Stainless Steel

- Durable, powder-coated finish – painted heads blend with decking material
- Driver bit included in each package

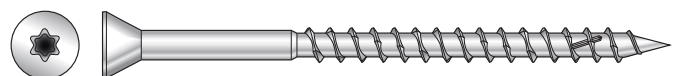

EB-TY® and Fastener Finder

EB-TY

EB-TY® Hidden Deck Fastener

The EB-TY biscuit provides a unique method of fastening deck boards that makes the fasteners virtually invisible. Fastening is done into the side of the board, leaving a fastener-free deck surface.

The EB-TY is a polypropylene biscuit fastener that fits into a slot on the edge of the deck boards. The EB-TY fasteners are inserted and fastened with a screw driven into the joist. Nesting each successive board against the EB-TY automatically ensures consistent spacing and uniform height.

- Easy to install since all fastening is done from the top side
- Affords easier deck resurfacing since nail heads are eliminated from the deck surface
- Suitable for pre-grooved decking or the builder can cut grooves with a biscuit joiner
- Formed from UV resistant polypropylene to last the life of the deck
- Stainless-steel #7 trim-head screws included
- Each carton includes installation instructions and enough EB-TY fasteners, screws and tapered lpe wood plugs to install 100 square feet of decking (assuming 6" wide boards, installed perpendicular to joists spaced 16" on center)



EBTYS



EBTT



EBTYLC

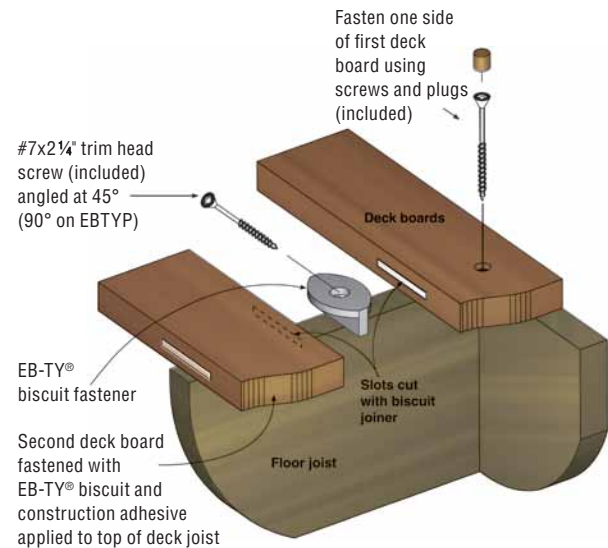

Search with Fastener Finder

Quickly search our wide array of fasteners to find exactly what you need. Search by multiple criteria, such as application, fastener-type, finish/material and model number. Explore our extensive product line in seconds in order to compare, specify or buy. Find the right fastener now by accessing our online Fastener Finder. Visit our website at www.strongtie.com/ff.

Select Criteria:

Fastener Type: Application: Material/Coating: Point Color:

Length:

Additional Criteria:

Head Type: Thread Type: Shank Type: Point Type:

Search Model Number:

Search Screw Size / Nail Gauge:

DECKTOOLS® – Deck Sales and Design Software

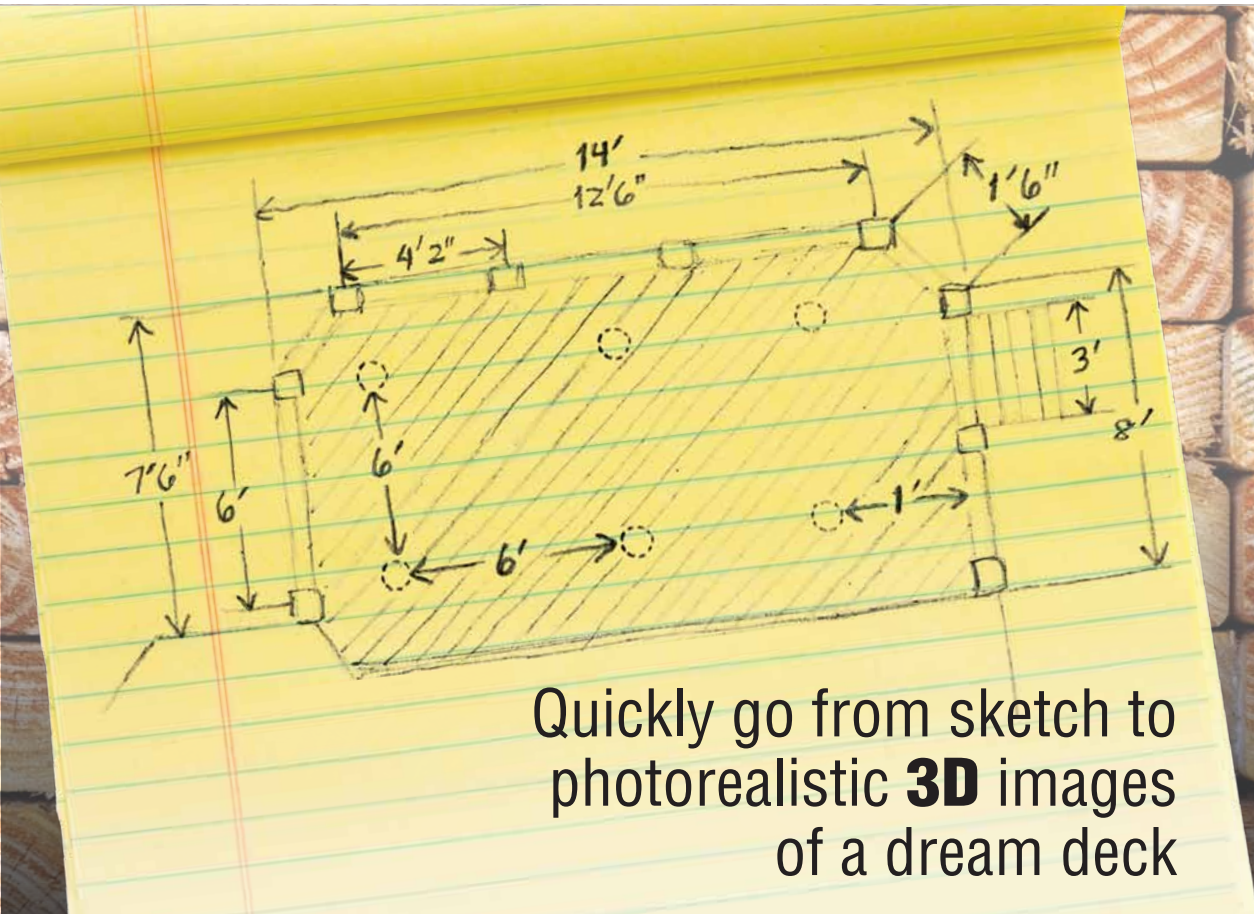

Quickly go from sketch to photorealistic **3D** images of a dream deck

Real wood finishes

Custom shapes and options

Complex designs



Explore your options,
and find out more about
DeckTools® software.

www.strongtie.com/decktools.



Power Tools:

Mobile Apps Online Calculators Software



Simpson Strong-Tie offers convenient ways to get information fast. Download software for connectors, anchors and lateral systems to help you find the right product for your job. Access a variety of online calculators, estimators, design applications and drawing details. And our literature library app puts our most popular catalogs in the palm of your hand.

To see our growing line of free software, web and mobile applications, call (800) 999-5099 or visit www.strongtie.com/software.

SIMPSON
Strong-Tie

This flier is effective until December 31, 2015, and reflects information available as of February 1, 2013. This information is updated periodically and should not be relied upon after December 31, 2015; contact Simpson Strong-Tie for current information and limited warranty or see www.strongtie.com.